

B o w s e r V i l l a g e C e n t r e P l a n

Schedule 'B' to accompany "Regional District of
Nanaimo Electoral Area 'H' Official Community
Plan Amendment Bylaw No. 1335.03, 2010"

Chairperson

Sr. Mgr., Corporate Administration

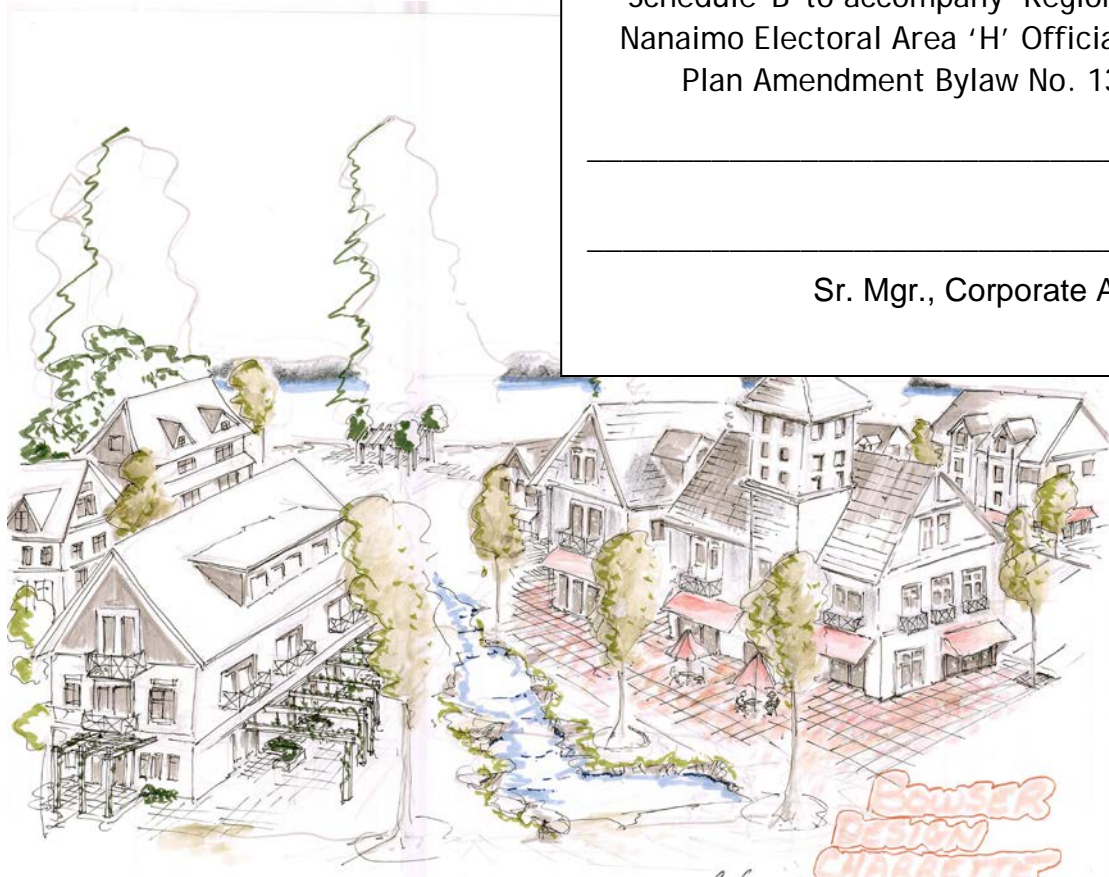

Living in Harmony with
Our Environment & Each Other



February 23, 2010

Consolidated September 30, 2020

This Page Intentionally Blank

Acknowledgments

This document is the result of the collaboration and dedication of community members, business owners, leaders, RDN staff, design professionals and others who care deeply about the future of Bowser Village Centre. Our gratitude goes out to:

Area 'H' Village Planning Advisory Group Members & those who helped make key meetings happen

Steve Anderosov	Donna De Bellefeuille	Bob Hunt	Roy Moore	Wendy Scott
Elissa Anthony	Loyd Dearlow	Hugh Jackson	Wayne Morm	Josianne Séguin
Joan Armstrong	Dave Desmeules	Deborah	Wayne Morrison	Norm Slater
Amar Bains	Jim Dennison	Johannessen	Erwin Mueller	Yvonne Slater
Olaf Barck	Lois Donnelly	Jo-Anne Jones	David Murray	Mac Snobelen
John Barrand	Steve Donnelly	Bill King	Judy Murray	John Stathers
Julie Barrand	Louise Duncan	Els King	Dave Nee Nee	Ross Stathers
Sally Barton	George Dussault	Brian Kingzett	Jan Nelms	Mary Stets
Dave Bartram	Marlene Dussault	Bruce Kirkbride	Clayton Neuwirth	Frank Stets
Joyce Bartram	Dianne Eddy	Christo Kuun	Roy Nex	Dick Stubbs
Lisa Bell	Barry Ellis	Michele Lacey	Rick Nickerson	Greta Taylor
Peter Bennett	Dennis Erickson	Michael Lamoureux	Trish Nickerson	Linda Tenney
Patty Biro	Larry Ethan	Robin Lamoureux	Dawn Osborne	Bon Thorburn
Robert Boorman	David Evans	Bruce Lane	Wayne Osborne	Fran Thorburn
Keith Brown	Kelly Faywray	Kathy Lane	Edward Pater	Lynette Twigge
Toni Brown	Brian Field	Rita Lewitz	Deb Penley	Lisa Verbicky
Marnie Burden	Wayne Foot	Rodney Luck	Gerry Quinn	Catherine Watson
Nick Bush	Evelyn Foot	Barb Lyotier	Angelika Quint	Sharon Waugh
Audrey Campbell	Rod Gentry	John Lyotier	Edith Quint	Gordon Webb
Jean Chaney	Peter Gerritsen	Don MacLean	Michael Recalma	Mark Webster
Travis Chaney	Al Grozell	Don Manness	Keith Reid	Darlene Wells
Sandy Christie	Murray Hamilton	Kerri Mason	Fred Ryvers	Earl Wiegans
Vi Chungranes	Ken Harris	Peter Mason	Ron Ryvers	Geo Williamson
Anne Copas	Lyle Harvey	Alvin Meldrum	Hanna Saefkow	Jo Williamson
Jim Crawford	Margaret Healey	Kay Meldrum	Diane Sampson	Brenda Wilson
Theresa Crawford	David C. Heenan	Don Milburn	Merle Schandt	Dave Winchar

Planning & Design Professionals who volunteered for the Bowser Charette

Randall Arendt	Stephen Bishop	Wayne Lee	Sebastian Moffatt	Leigh Sifton
Julia Baker	Victoria Drakeford	Peter Levar	Gary Noble	Dan Guentz
Nathan Bishop	Angela Evans	Linda Levar	Luke Sales	

RDN Staff who provided technical assistance and attended meetings to support the process

Lisa Bhopalsingh	Jani Drew	Kerri House	Elaine McCulloch	Kevin Robillard
Stephen Boogaards	Sean DePol	Laura Kitely	Wendy Marshall	Tom Sohler
Ginny Cosgrove	Mike Donnelly	Peter Kuziek	Joan Michel	Paul Thompson
Susan Cormie	John Finnie	Dale Lindsay	Chris Midgeley	Paul Thorkelsson
Lindsay Dalton	Geoff Garbutt	Elaine Leung	Wayne Moorman	

Agency Representatives who provided technical assistance and attended meetings to support the process

Cpl Gary Cox	Glen Gibson	Scott Henley	Gordon Lundine	Brian McIntosh
Dave Edgar				

And last but not least a very special thank you to Josianne Séguin, Principal Tony Saremba, 'Mr. Seline' and his grade 4/5 class at Bowser Elementary who enthusiastically shared their ideas for Bowser Village Centre.

This Page Intentionally Blank

Table of Contents

1 Introduction



Introduction

2 Sustainability Principles



Principles

3 Policies & Implementation



Policies & Implementation

4 Land Use Concept & Designations



Land Use Concept

5 Development Permit Area



Development Permit Area

Table of Contents Continued...

Appendices

Appendix A Glossary

Appendix B Public Process

Appendix A
Glossary

Appendix B
Public Process

List of Maps

1 Introduction

Map 1.3.1	Location of Bowser Village Centre	Section 1	Page 2
Map 1.4.1	Bowser Village Centre Plan Area	Section 1	Page 3

4 Land Use Concept & Designations

Map 4.1.2	Proposed Land Use Concept Map	Section 4	Page 2
Map 4.1.3	Proposed Mobility Map	Section 4	Page 3
Map 4.1.4	Proposed Building Height Map	Section 4	Page 4
Map 4.2.6	Ideas for Potential Greenways, Parks & Trails	Section 4	Page 16
Map 4.2.7	Example Concept for future Use Area	Section 4	Page 17

1 Introduction

THIS PAGE INTENTIONALLY BLANK

1.1 Bowser Village Centre Plan Overview

Based upon sustainability principles and goals, the Bowser Village Centre Plan provides direction and policies that reflect how the residents of Electoral Area 'H' wish to see the Bowser Village Centre change and grow over time.

The Land Use Concept and Designations together with Policies and Development Permit Area Guidelines, detail the desired types and arrangements of land use within the Bowser Village Centre.

This plan provides direction on community priorities for environmental protection (including aquifer protection), safety from crime, resilience to disasters, pedestrian friendly development, affordable housing, seniors housing, access to alternative transportation and recreation, fiscal accountability, transparency in governance and inclusive planning processes.

The Bowser Village Centre Plan also addresses key issues relating to **reducing green house gas emissions (GHG)** and the associated **impacts of climate change** by:

- Encouraging compact housing, employment, and transportation choices that promote the efficient use of energy and resources.
- Supporting the use of planning and design to adapt or mitigate predicted impacts of climate change including sea level rise, and weather extremes.

1.2 Benefits of Village Planning

By capturing the community's direction for future change, the Bowser Village Centre Plan will:

- Provide a structure for residents to focus on priority issues and opportunities, develop solutions, and ultimately influence decisions about future change.
- Give developers a clear understanding of what the community wants to see built in the Bowser Village Centre so that they are better able to develop projects that meet community expectations.
- Provide the RDN Board and Planning Staff with a better understanding of how residents would like to see Bowser Village Centre evolve to accommodate growth sustainably.
- Be used as a valuable tool to assist the RDN Board and Planning Staff in evaluating how well development proposals meet community expectations as reflected by the plan.
- Act as a resource/ reference that shows community direction in order to leverage funding for projects that are consistent with the goals, objectives and policies of the plan.

1 Introduction

1.3 Regional and Provincial Context

Bowser Village Centre is located in Electoral Area 'H' of the Regional District of Nanaimo (RDN). Overlooking the Strait of Georgia and the coastal mountains of the B.C. Lower Mainland, this seaside village is part of an area known as 'Lighthouse Country'. Situated on Highway 19A (Old Island Highway), Bowser is approximately 35 km (21 miles) south east of the City of Courtenay and 21 km (13 miles) north west of the Town of Qualicum Beach.

Map 1.3.1: Location of Bowser Village Centre in relation to Area 'H', RDN and Vancouver Island¹

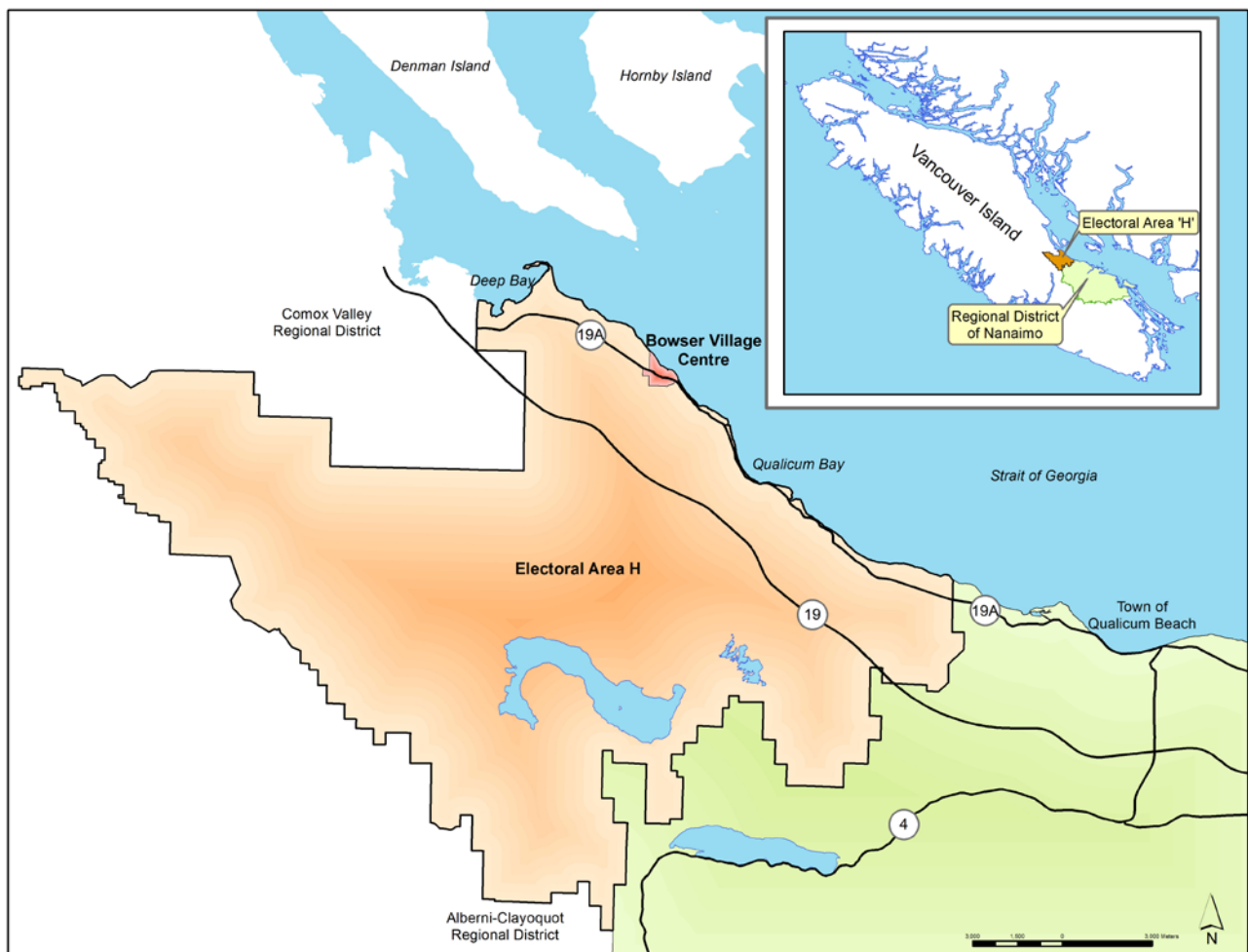

¹ Bylaw 1335.06 adopted December 12, 2017

1.4 Plan Area

The Plan Area consists of an area of 92.5 hectares outlined in red on Map 2 (below) which is a combination of two areas: the triangular shape of the “Original Boundary Area” of the Bowser Village Centre as it was identified in the OCP (approximately 50.7 hectares/125.5 acres), plus an additional rectangular area called the “Future Use Area” to the west along Crosley Road (approximately 41.8 hectares/103.5 acres).

Map 1.4.1: Bowser Village Centre Plan Area²

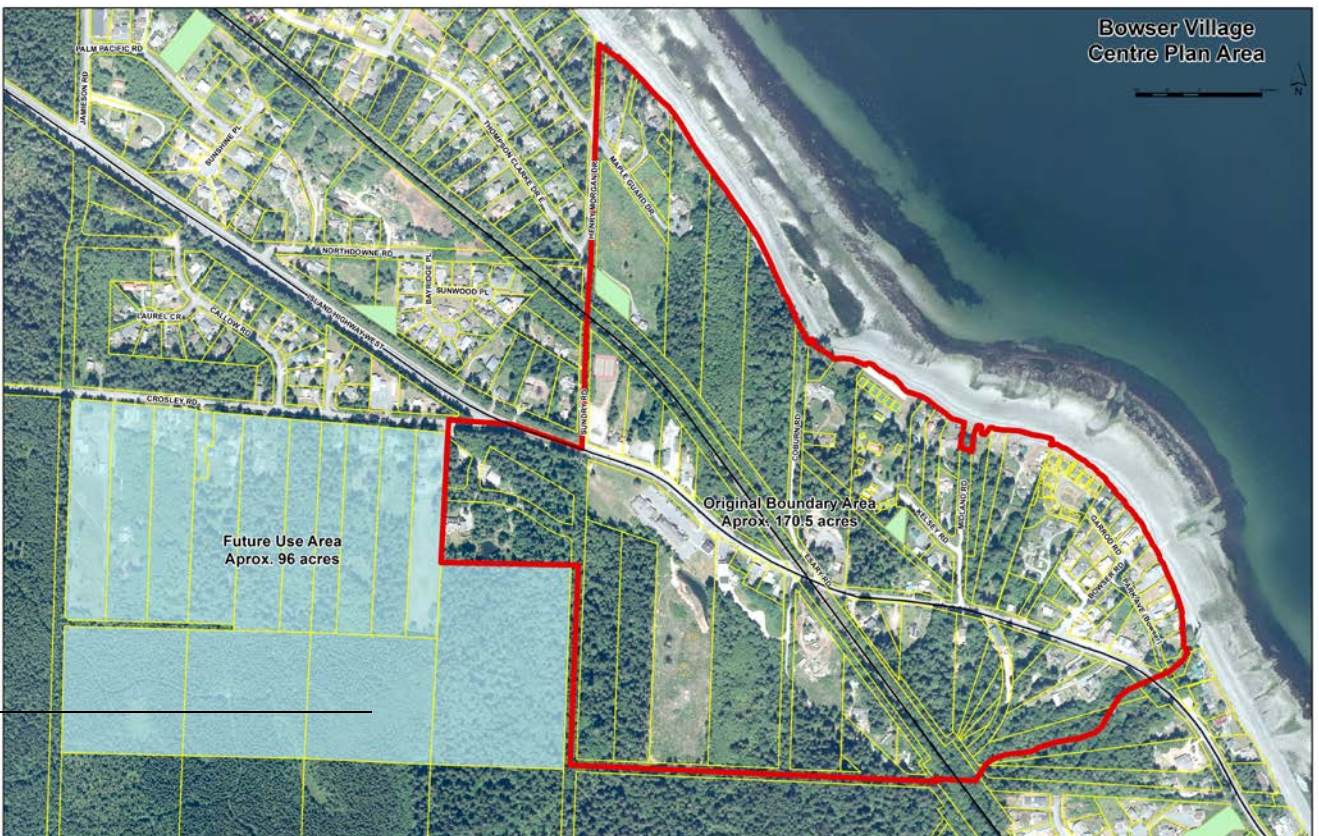

² Bylaw 1335.06, Adopted December 12, 2017

1 Introduction

1.5 Plan Authority

The Bowser Village Centre Plan is adopted as a bylaw amendment to the Electoral Area 'H' Official Community Plan (OCP, Bylaw No. 1335, 2004).

The Bowser Village Centre Plan is the principal guiding document for all land use decisions within the Bowser Village Centre boundary.

Where a particular issue is not covered by the Bowser Village Centre Plan, the Area 'H' OCP will be consulted for direction. Where a conflict exists between the OCP and the Bowser Village Centre Plan, the designations and/or policies of the Bowser Village Centre Plan will take precedence within the designated Bowser Village Centre Plan Area.

1.6 Plan Application

The Bowser Village Centre Plan will be applied in the review of all planning and land use matters within the Bowser Village Centre Plan Area. Applications for development, re-development and public improvement projects must be consistent with plan policies.

The land use direction of the Bowser Village Centre Plan will be used to review and revise RDN Land Use and Subdivision Bylaw 500, 1987 (Zoning Bylaw 500) to ensure that future applications for re-zoning are consistent with the direction provided in the Village Centre Plan.

Variations to Zoning Bylaw 500 may be required to meet the policies and guidelines of this Plan.

It is recognized that some current land uses and development allowed under existing zoning are not consistent with the **land use designations** shown on the land use concept map.

This plan is intended to illustrate a preferred pattern of land use as

development and re-development occurs. It is not intended to change the use of land in the immediate future. Future zoning changes will be initiated by property owners and not imposed by the RDN.

This plan identifies a variety of desirable community amenities. The provision of community amenities will be considered as part of re-zoning applications.

1.7 Plan Monitoring & Review

The Bowser Village Centre Plan will be reviewed in conjunction with the Electoral Area 'H' Official Community Plan review process.

1.8 Relationship to other RDN plans

This section describes briefly how the Bowser Village Plan relates to other key RDN strategic plans and regulations.

The diagram shows how the Bowser Village Centre Plan fits into the hierarchy of RDN plans and strategies.

The 2006-2009 RDN Board Strategic Plan "Leadership in Creating Sustainable Communities" outlines the RDN vision for a sustainable region: *"In the year 2030, the Regional District of Nanaimo is a socially,*

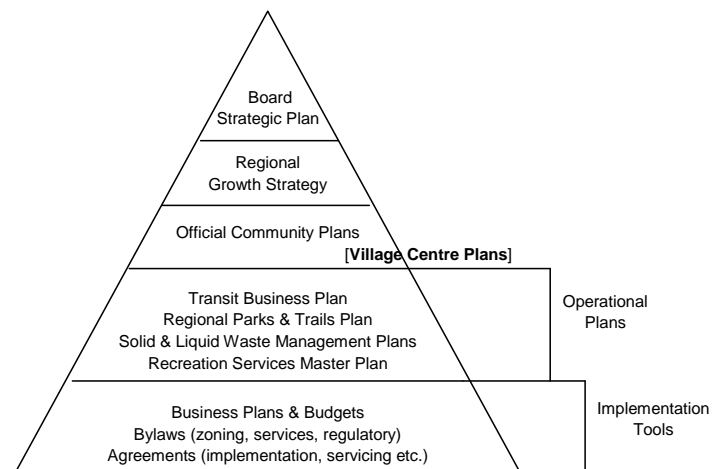

economically and environmentally healthy region, where residents meet their needs without compromising the ability of future residents to do the same.”

The Strategic Plan provides direction to the Regional Growth Strategy (RGS) which in turn provides direction to several community level strategic plans (including OCP’s and Village Centre Plans).

The policies and actions of the Electoral Area ‘H’ OCP and Village Centre Plans are implemented through regulatory bylaws (including zoning, subdivision and servicing bylaws) along with the allocation of resources through departmental business plans and budgets.

1.9 Village Centres in the RDN

Village Centres are intended to be the focus of housing, employment and service provision in unincorporated rural areas of the Regional District of Nanaimo.

Village Centres are part of the RDN’s Regional Growth Strategy focus of managing growth in order to achieve sustainability goals.

Directing and encouraging denser development within rural Village Centres will help protect and enhance rural qualities of life and interrelated environmental values by:

- Creating conditions that increase opportunities to live, work, learn and play in compact, complete rural village centres.
- Increasing the feasibility of providing cost effective servicing and amenities by concentrating demand.
- Linking adjacent suburban areas to Village Centres through the use of

bicycle paths, pedestrian walkways, and senior and handicapped accessible scooter pathways to increase healthy, energy efficient modes of transportation, and reduce private vehicle use.

Bowser, Qualicum Bay and Dunsmuir were first designated as Village Centres during the Shaw Hill-Deep Bay Official Community Planning Process in 1996, and subsequently incorporated into the 1997 Regional Growth Strategy and later revisions to the Electoral Area ‘H’ Official Community Plan in 2004 and 2017³.

Each of the three Village Centres were designated in recognition of their existing and anticipated future role in concentrating retail, service, institutional, recreational and tourist activity.

In addition, following the decision to focus on developing a plan for Bowser Village Centre first, the majority of the Village Planning Advisory Group agreed that the Deep Bay Area should be reviewed along with Qualicum Bay and Dunsmuir when considering the role and status of other Village Centres in Electoral Area ‘H’.

1.10 Initiation of the Area ‘H’ Village Planning Project

Working with the community to develop detailed Village Centre plans is an implementation action item of the 2004 Electoral Area ‘H’ OCP.

The OCP provides some general policy direction for Village Centres, but does not detail the types and arrangement of land uses that are desirable within Village Centres.

Initiated in June 2008, the purpose of the Area ‘H’ Village Planning Project was to work with the community to:

³ Bylaw 1335.06, Adopted December 12, 2017

1 Introduction

- Carry out a planning process based on Sustainability Principles, and which assists the Area 'H' Community in determining how it would like to address these principles through village centres and village planning.
- Prepare a village plan(s) which provides comprehensive guidelines for the development of village centres, and which recognizes the relationship of the village centres to one another and to the surrounding areas.

1.11 Focus on Bowser Village Centre

In March 2009, the Area 'H' Village Planning Advisory Group decided to focus planning efforts on Bowser Village Centre. This decision reflected the community's view of Bowser as the current and historical concentration of commercial activity in Electoral Area 'H'.

Choosing Bowser as the first village centre to be planned was regarded as an effective way of focusing resources between March and fall 2009. Lessons learned from the Bowser Village Centre planning process may be applied during the review and planning for other village centres.

1.12 Community Participation

The Bowser Village Centre Plan is the product of active community participation and guidance. Dedicated community members, community leaders and business owners worked collaboratively with RDN staff, and design professionals to share knowledge and ideas that resulted in the direction and policies in this plan.

The community participation/ public consultation process included:

- The formation of an open Community Advisory Group
- Open Houses and an Information Event
- Booths at community events
- A two day village planning charette

Appendix B provides a more detailed overview of community participation.

Area H Village Planning Open House Bowser Village Centre Plan

As part of the Area 'H' Village Planning Process, residents of Electoral Area 'H' are invited to view and provide feedback on a draft plan for Bowser Village Centre.

Based on sustainability principles, the draft plan outlines proposed policies, future land uses and design guidelines for land within the Bowser Village Centre Boundary.



**Wed. October 28th
6:30—8:30 pm**

Lighthouse Community Centre
240 Lions Way, Qualicum Bay

Please Drop By
to let us know your thoughts
on the draft Plan for a
Sustainable Bowser Village Centre

For more information please contact:
Lisa Bhopsal Singh, RDN Senior Planner
Email: areahvillageplanning@rdn.bc.ca
Phone: 250-390-6510 Fax: 250-390-7511
Toll Free: 1-877-607-4111

DRAFT PLAN
The draft plan can be viewed online at
www.rdn.bc.ca/Area_H_Village_Planning.
Hard copies of the draft are also available at
the Beacon Office in Bowser.

EVERYONE WELCOME



1.13 Abbreviations

Abbreviations used in this plan include the following:

BCAS	BC Ambulance Service
BCT	BC Transit
BWD	Bowser Water District
BHBVFD	Bow Horn Bay Volunteer Fire Department
COP	Citizens on Patrol
DBVFD	Deep Bay Volunteer Fire Department
DBID	Deep Bay Improvement District
DFO	Fisheries and Oceans Canada
DPA	Development Permit Area
DP	Development Permit
GHG	Green House Gas
ICF	Island Corridor Foundation
ILMB	Integrated Land Management Bureau
LCBA	Lighthouse Country Business Association
LRC	Lighthouse Recreation Committee
MCRD	Ministry of Community and Rural Development
MOE	Ministry of Environment
MHLS	Ministry of Healthy Living and Sport
MOFR	Ministry of Forests and Range
MOTI	Ministry of Transportation and Infrastructure
OCP	Official Community Plan
POSAC	Area 'H' Parks and Open Space Advisory Committee
QFN	Qualicum First Nation
RCL	Royal Canadian Legion
RDN	Regional District of Nanaimo
RGS	Regional Growth Strategy
VIHA	Vancouver Island Health Authority
VIU	Vancouver Island University

Section 2

Table of Contents

- 2.1 Sustainability Definition
- 2.2 Guiding Principles



2 Sustainability Principles

2.1 Electoral Area H Village Planning - Sustainability Definition

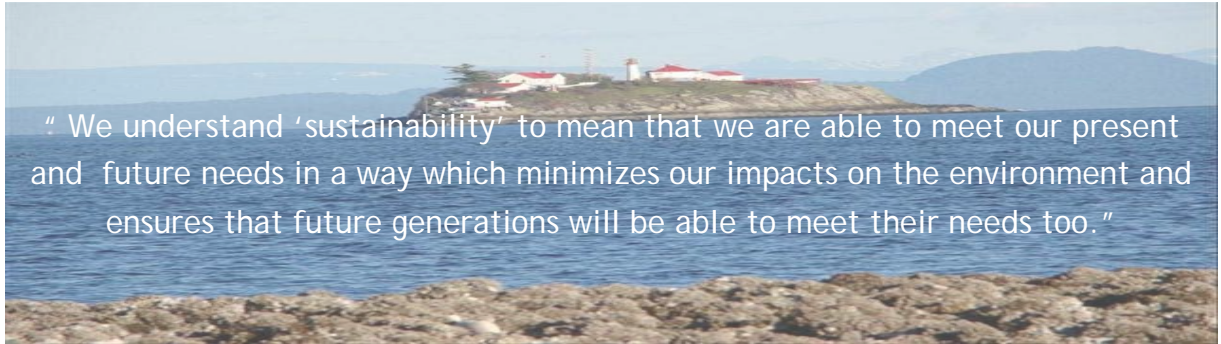

2.2 Guiding Principles

The following principles were developed with sustainability in mind and are intended to guide the planning and development of Bowser Village Centre as a sustainable community.

Principle 1 - Build Smarter, Safer, Healthier Communities

- Public Health and Safety is our first priority and as such requires consideration be given to: land stability, safe supply of water, appropriate waste management, and emergency response infrastructure and capabilities.
- The quantity and quality of water in our Aquifer is a central thought for all planning.



Principle 2 - Design with Nature in Mind

- Recognize that everything that we do in our community, whether it relates to our social, cultural or economic needs, affects our natural environment, positively or negatively.
- Recognize that conservation of natural resources provides long term environmental and economic benefits.



Principle 3 - Protect and promote a healthy environment as it is the foundation of a resilient society, culture and economy

- Consider how our environmental, social, cultural, and economic needs are interconnected.
- Recognize that a healthy environment is the foundation of a resilient and thriving society, culture and economy.



Principle 4 - Ensure equity amongst all citizens and across generations, including future generations

- Meet our near term sustainability goals without compromising the ability of future generations to meet their goals also. This means understanding what the long term benefits and costs are in our planning.
- Meet the present and future social, cultural, and economic needs of the community and ensure that these needs can be met in the development of our village centres and village planning.



Principle 5 - Respect the qualities of place that foster community pride and a sense of belonging and ownership

- Recognize that community pride is affected by the quality of planning and community aesthetics.



Principle 6- Foster community participation in planning and accountability for decisions and actions

- Ensure that the community is actively engaged in the planning process.
- Ensure that there is transparency in governance.



Section 3

Table of Contents

- 1 Plan and design with nature in mind
- 2 Build a safer more resilient community
- 3 Be more accountable and inclusive
- 4 Increase community pride and ownership
- 5 Increase sustainable economic activity
- 6 Connect people and places in ways that promote safe, enjoyable and healthy movement



3 Policies & Implementation

THIS PAGE INTENTIONALLY BLANK

This section of the Bowser Village Centre Plan contains goals, objectives and policies along with specific direction for how the various policies will be implemented.

This section is organized under six broad goal areas listed below. Each goal contains more specific objectives, policies and actions designed to achieve the goal.

Goals

- 1 Plan and design with nature in mind
- 2 Build a safer more resilient community
- 3 Be more accountable and inclusive
- 4 Increase community pride and ownership
- 5 Increase sustainable economic activity
- 6 Connect people and places in ways that promote safe, enjoyable and healthy movement

Interrelationship of Goals, Objectives and Policies

It is important to note that there are close linkages between all the goals with several instances where meeting the objectives of one goal helps achieve the objectives of another. For example, reducing Green House Gas (GHG) emissions is addressed by a variety of goals, objectives and policies in different sections. Below are a few of the goals and objectives that address GHG emissions. There are also more policies in the plan that support GHG emissions reductions without explicitly mentioning it.

Goals and Objectives

1.1 Develop a Compact, Complete Village Centre

- 1.1.1 To reduce green house gas (GHG) emissions by:
 - a. increasing opportunities for alternative transportation.
 - b. creating opportunities for multi-family and mixed use development.

1.3 Enhancing Biodiversity

- 1.3.4 To encourage retention and planting of trees and landscaping to enhance biodiversity and help counteract the effects of GHG emissions by increasing the uptake of carbon dioxide in plant matter.

1.6 Energy Efficiency

- 1.6.1 To reduce GHG emissions through use of energy efficient site planning, building design, operation and maintenance best practices.

2.4 Climate Change

- 2.4.1 To build greater understanding of the impact of individual energy consumption on GHG emissions and climate change (through transportation, housing, employment and recreational choices) and encourage individual actions to reduce GHG emissions.

6.1 Encouraging Active Transportation

- 6.1.1 To increase healthy, energy efficient modes of transportation, and reduce private vehicle use.

6.3 Transit

- 6.3.1 To provide viable, sustainable and affordable alternatives to private vehicle use within Bowser and between other neighbourhoods and larger urban centres.

3 Policies & Implementation

Defining Goals, Objectives and Policies

Understanding the relationship between the goals, objectives and policies of this plan is essential to both implementing the plan and evaluating how effective the plan is in achieving community desires.

- **Goals** describe the desired long term outcome;
- **Objectives** represent a measurable specific result or step towards achieving the goal; and
- **Policies** specify the course of action to achieve how the objectives and ultimately the goal will be reached.

The policies in this plan provide specific direction to the RDN Board and staff, the community, land owners and developers, and provincial and federal agencies on future uses and activities in the Bowser Village Centre.

Policy Language Defined

Where a policy contains the words 'shall' or 'will' the actions outlined to undertake the policy are considered mandatory. However, this does not preclude selecting alternative actions that can clearly achieve the intent of the policy.

Use of the words 'may' or 'should' indicate that best efforts will be made to meet a policy with this wording, however the implementation of the policy is more flexible and open to discretion.

Implementation

Implementation **actions** are provided for each policy, together with **who** is responsible for undertaking the actions and the **timeframe** for completing the action item.

Who Outlines who is responsible or should be involved in undertaking an action/implementing a policy.

RDN All departments of the Regional District of Nanaimo

Sr Gov Senior Government (federal/provincial agencies)

Com Community members of Electoral Area 'H'

BCAS	BC Ambulance Service	LRC	Lighthouse Recreation Committee
BWD	Bowser Water District	MCRD	Ministry of Community & Rural Development
BCT	BC Transit	MOE	Ministry of Environment
BHBVFD	Bow Horn Bay Volunteer Fire Department	MHLS	Ministry of Healthy Living and Sport
COP	Citizens on Patrol	MOFR	Ministry of Forests and Range
DBVFD	Deep Bay Volunteer Fire Department	MOTI	Ministry of Transportation & Infrastructure
DBID	Deep Bay Improvement District	POSAC	Area 'H' Parks and Open Space Advisory Committee
DFO	Fisheries and Oceans Canada	QFN	Qualicum First Nation
ICF	Island Corridor Foundation	RCL	Royal Canadian Legion
ILMB	Integrated Land Management Bureau	VIU	Vancouver Island University
LCBA	Lighthouse Country Business Association	VIHA	Vancouver Island Health Authority

Timing

The timing for implementing policies and actions is as follows:

Immediate (should be initiated and/or completed by 2010)

Ongoing (should be initiated during 2010 with no planned completion date)

Short Term (should be addressed within 5 years)

Long Term (should be addressed within 5-10 years)

Implementation

Costs

Achieving the goals and objectives of the Bowser Village Centre Plan will require a variety of resources. While there are several policy actions that RDN departments may be able to undertake as part of regular operations, others will require special resources that may involve:

- Prioritizing options and timely review of costs
- Developer contributions
- Consider creating service areas in accordance with the *Local Government Act* for properties that directly benefit from improvements within the Bowser Village Centre
- Seeking grants and contributions from other levels of government
- Voluntary community activities to generate actual or in kind contributions
- The provision of community amenities as part of re-zoning applications

The identification of community priorities for different activities will determine the allocation of resources needed to implement the plan on an annual basis.

3 Policies & Implementation

Goal 1. Plan and Design with Nature in Mind

1.1. Develop a Compact, Complete Village Centre

Objectives

- 1.1.1 To reduce green house gas (GHG) emissions by:
 - a. increasing opportunities for alternative transportation; and
 - b. creating opportunities for multi-family and mixed use development.
- 1.1.2 To protect rural character (environmental, agricultural and resource values) outside Bowser Village Centre by increasing density within Bowser Village Centre.
- 1.1.3 To increase average residential density in Bowser Village Centre to 20 units per hectare by 2025 with a target of 30 units per hectare by 2040.
- 1.1.4 To increase the diversity of retail shops, services, housing, recreation and employment opportunities in Bowser Village Centre.

Policies	Related Actions	Who	Time
1.1.1 The RDN shall explore and implement innovative methods of increasing density within Bowser Village Centre. Consider density incentives, transfers and fast tracking development applications.	<ul style="list-style-type: none"> a. Conduct a study of options for increasing density within Bowser Village Centre. b. Review and update Zoning Bylaw 500 to facilitate increased density. Consider setting minimum density requirements. c. Consider comprehensive development zones for mixed use commercial areas. 	RDN	Short Term
1.1.2 Rezoning proposals shall meet the density target in the “more realistic” column of Figure 4.1.5 at a minimum. Where the full build-out of a property is intended to be phased or developed over time, the rezoning should include a plan for phasing where the full build-out meets the objectives and policies of this Plan. ⁴	<ul style="list-style-type: none"> d. When reviewing rezoning applications, require that the “more realistic” density targets are the minimum density of the new zone. 	RDN	Ongoing

⁴ Bylaw 1335.06, Adopted December 12, 2017

Goal 1. Plan and Design with Nature in Mind

1.2. Water Conservation and Protection

Objectives

- 1.2.1 To meet 50% of new water needs through conservation by 2020.
- 1.2.2 To have 33% more efficient water use by 2020.
- 1.2.3 To sustain future access to reliable, safe, untreated drinking water supplied by Bowser Water District and Deep Bay Improvement District.
- 1.2.4 To have all new construction use rainwater capture to help meet irrigation needs for landscaping and gardening by 2020.
- 1.2.5 To explore the feasibility of grey water use for both internal non-potable uses and irrigation.
- 1.2.6 To increase the 'green' function and appearance of streetscapes with one 'Green Street' established in Bowser Village Centre within the next 5-10 years.

Policies	Related Actions	Who	Time
1.2.1 The RDN will use Development Permits (DPs) as a tool to protect and enhance ground, surface and coastal water from the negative impacts of development.	<ul style="list-style-type: none"> a. The RDN may require hydro geological studies as part of DP applications. b. Require DPs prior to re-zoning or subdivision of land. 	RDN	Ongoing
1.2.2 The RDN will encourage Deep Bay Improvement District and Bowser Water District to develop strategies for groundwater protection.	<ul style="list-style-type: none"> c. Explore options to protect well head areas. d. Implement an educational and awareness program to protect groundwater. This may include signage, workshops, brochures and web based information. 	RDN MOE VIU DBID BWD MHLS VIHA	Short Term
1.2.3 The RDN supports the ongoing monitoring of groundwater quantity and quality.	<ul style="list-style-type: none"> e. The RDN will request that water suppliers coordinate with other agencies to monitor groundwater. 	RDN MOE VIU DBID BWD MHLS VIHA	Short Term
1.2.4 The RDN will encourage collaboration between various agencies to provide ongoing public awareness about the importance of protecting ground, surface and coastal water quality.	<ul style="list-style-type: none"> f. The RDN will work with service providers to identify ways and means to work together to provide information on protecting ground, surface and coastal water quality. g. Promote findings of VIU groundwater vulnerability mapping studies. 	RDN MOE VIU DBID BWD MHLS	Short Term

3 Policies & Implementation

Policies	Related Actions	Who	Time
1.2.5 The RDN will continue to promote the environmental and economic benefits of water conservation and demonstrate how to conserve water use through building and landscaping design and behaviour changes.	<ul style="list-style-type: none"> h. Continue to use RDN Team Watersmart education and awareness programs to promote water conservation. i. Continue to work collaboratively with Bowser Water District and Deep Bay Improvement District to support their ongoing efforts to implement water conservation measures. 	RDN BWD DBID	Ongoing
1.2.6 The RDN supports the development of integrated ground/rain water management planning.	<ul style="list-style-type: none"> j. Look for opportunities to encourage integrated ground/rain water management with developers, various agencies and other partners. 	RDN MOTI DFO MOE MHLS	Long Term
1.2.7 The RDN supports the development of on-site rain water management systems that aim for zero run-off and re-use of grey water for landscaping for all new commercial, institutional and multi-family development sites in Bowser Village Centre.	<ul style="list-style-type: none"> k. Provide developers with information on, on-site rain water management systems. l. Review barriers to, and explore options for, the installation and use of grey water re-use. m. Explore options for subsidies for the purchase of rain water capture materials. 	RDN BWD DBID VIHA MHLS	Short Term
1.2.8 The RDN supports the installation of low flow plumbing fixtures in all new and renovated buildings in Bowser Village Centre.	<ul style="list-style-type: none"> n. Work with the provincial government to develop legislation or a bylaw to require installation of low flow plumbing fixtures. o. Encourage Bowser and Deep Bay Water Improvement Districts to distribute information promoting installation of low flow plumbing fixtures. 	RDN BWD DBID Sr. Gov	Short Term
1.2.9 The RDN will encourage use of xeriscaping using native plant species in all developments including public open spaces.	<ul style="list-style-type: none"> p. Explore opportunities with the RDN to consider a xeriscaping demonstration project as part of the creation of public open space in Bowser Village Centre. 	RDN	Short Term
1.2.10 The RDN supports the use of low maintenance landscaping methods that involve maximizing rain/storm water infiltration (such as swales, grasscrete, roof gardens, rainwater catchment areas including green streets).	<ul style="list-style-type: none"> q. Use Development Permits to guide development of 'Green Streets' and landscaping for public and private open space. r. Consider a 'Green Street' demonstration project. 	RDN	Short Term
1.2.11 The RDN will discourage the use of impervious surfaces and encourage the use of alternate materials to increase infiltration (e.g. brick/concrete pavers, pervious asphalt/cement, crushed gravel, grasscrete).	<ul style="list-style-type: none"> s. Review and update subdivision and servicing bylaws. t. DP requirement to address environmental concerns. u. Revise Zoning Bylaw to limit impervious surfaces. 	RDN	Short Term

Goal 1. Plan and Design with Nature in Mind

1.3. Enhancing Biodiversity

Objectives

- 1.3.1 To ensure that future development assists in preserving and enhancing biodiversity.
- 1.3.2 To integrate planning for biodiversity with parks and trails planning.
- 1.3.3 To mitigate negative impacts of existing and future development on sensitive ecosystems and species.
- 1.3.4 To encourage retention and planting of trees and landscaping to enhance biodiversity and help counteract the effects of GHG emissions by increasing the uptake of carbon dioxide in plant matter.

Policies	Related Actions	Who	Time
1.3.1 The RDN will collaborate with MOE, and local environmental groups to develop programs to enhance biodiversity on public and private property by encouraging the preservation and use of native plants and removal of invasive species.	<ul style="list-style-type: none"> a. Provide information on environmental damage caused by invasive species and methods of control on private property. b. Develop a strategy for invasive plant removal and enhancement of habitat on parks and trails. 	RDN MOE COM	Short Term
1.3.2 The RDN will collaborate with other levels of government and local environmental groups to inventory species and habitat within Bowser Village Centre.	<ul style="list-style-type: none"> c. Request that provincial and federal agencies and non-profit environmental groups conduct inventories of species at risk and identify strategies for preserving and enhancing habitat on public and private property. d. Request that private property owners allow access to their lands to conduct inventories. e. Prioritize key areas for habitat and environmental preservation as part of parkland acquisition. 	RDN QFN MOE COM	Long Term
1.3.3 The RDN will develop a program (using signage, education and policies) to encourage the elimination of pesticides and herbicides in Bowser Village Centre and adjacent lands.	<ul style="list-style-type: none"> f. Explore options available for controlling pesticide use on public and private lands. g. Provide information on environmental and human health risks caused by pesticide and herbicide use. 	RDN MOE VIHA	Short Term

3 Policies & Implementation

Policies	Related Actions	Who	Time
1.3.4 The RDN will consider the potential impacts of sea level rise in reviewing development proposals along the coast of Bowser Village Centre.	h. Work with other levels of government, and local community groups to identify and implement strategies to enhance coastal zone resilience and to mitigate the impacts of sea level rise.	RDN QFN DFO MOE Com	Ongoing
1.3.5 The RDN strongly supports integrated coastal zone management to protect the marine ecosystem and restore coastal processes affected by development in the Bowser Village.	i. Work with other levels of government and local community groups to identify and implement strategies to enhance the coastal environment in Bowser Village Centre and balance competing interests.	RDN QFN DFO MOE Com	Ongoing
1.3.6 The use of marine retaining walls and other “hard” surfaces such as seawalls, concrete groynes, gabions, and rip rap shall only be supported where a qualified professional has determined that “soft” approaches to shoreline stabilization such as vegetatoin enhancement, upland drainage control, biotechnical measures, beach enhancement, anchor trees, and gravel placement are not appropriate given site specific conditions. In addition, the construction of shoreline stabilization measures including marine retaining walls should be in compliance with the <i>Regional District of Nanaimo Marine Retaining Wall Policy</i> , as amended from time to time.	j. Work with property owners, qualified professionals, DFO, ILMB and MoE to develop solutions to beach stabilisation issues that do not result in a further hardening of the shoreline and will not have an impact on the surrounding area including adjacent upland property.	RDN DFO ILMB MoE Com	Ongoing

Goal 1. Plan and Design with Nature in Mind

1.4. Wastewater Management

Objectives

- 1.4.1 To work with interested land owners in Bowser Village Centre to develop an innovative approach to providing cost effective, environmentally friendly wastewater management systems.
- 1.4.2 To establish a septic inspection/maintenance program to identify and address failing on-site systems.
- 1.4.3 To establish servicing for properties with failing onsite systems to alleviate threats to human health and the environment.

Policies	Related Actions	Who	Time
<p>1.4.1 The RDN will work with interested land owners to explore options for innovative wastewater management systems in Bowser Village Centre. Systems considered should be able to accommodate higher density growth while meeting the community's desire for environmentally friendly, small scale and cost effective treatment systems. Modular treatment systems that are expandable will be considered.</p>	<p>a. Initiate a study to work with interested land owners to explore a range of wastewater management options for Bowser Village Centre. The study should clearly describe the costs and benefits of different approaches.</p> <p>b. Work with ILMB and MOE to review options for siting community wastewater management facilities on Crown lands within or adjacent to Bowser Village Centre.</p> <p>c. Consider creating service areas in accordance with the <i>Local Government Act</i> for properties that directly benefit from improvements within the Bowser Village Centre.</p>	<p>RDN Land - Owners VIHA MOE RDN ILMB</p>	<p>Immediate</p>
<p>1.4.2 The RDN will encourage the development of common waste water management systems that are capable of being expanded.</p>	<p>d. Work with land owners to encourage collaboration on the development of wastewater management systems.</p> <p>e. Consider requiring through rezoning applications, that multi-residential and intensive residential development install, as a minimum, a Type III system that is expandable to service additional development in the future.</p>	<p>RDN Land - Owners VIHA MOE</p>	<p>Ongoing</p>
<p>1.4.3 The RDN will consider Bowser Village Centre as a pilot project for innovative 'green' wastewater management systems.</p>	<p>f. Explore funding options for implementing 'green' wastewater treatment options in Bowser Village Centre.</p>	<p>RDN Snr Gov</p>	<p>Short Term</p>
<p>1.4.4 The RDN will design community wastewater systems to meet all relevant pollution control regulations and to be compatible with adjacent land uses.</p>	<p>g. Work with VIHA and MOE to review wastewater management systems.</p>	<p>RDN VIHA MOE MHLS</p>	<p>Ongoing</p>
<p>1.4.5 The RDN will strongly encourage the regular inspection of septic systems by a qualified engineering professional and the immediate replacement of failing septic systems.</p>	<p>h. Request that VIHA and MOE monitor the condition of septic systems.</p> <p>i. The RDN will review options for a region wide septic system inspection program.</p>	<p>RDN VIHA MOE MHLS</p>	<p>Ongoing</p>
<p>1.4.6 If a wastewater management system exists within Bowser Village Centre, connection to the system is a requirement of any rezoning or amendment to this Plan.⁵</p>	<p>j. Establish a process for requiring connection to wastewater management system at time of rezoning.</p>	<p>RDN</p>	<p>Short Term</p>

⁵ Bylaw 1335.06, Adopted December 12, 2017

3 Policies & Implementation

Goal 1. Plan and Design with Nature in Mind

1.5 Solid Waste Management

Objectives

- 1.5.1 To divert 75% of all household and commercial waste from the RDN landfill by 2010.
- 1.5.2 To divert all compostable materials from household and commercial waste by 2010.
- 1.5.3 To strive to achieve Zero Waste entering the RDN landfill.

Policies	Related Actions	Who	Time
1.5.1 The RDN will work with local residents and businesses to explore viable, creative options to reach targets for Zero Waste through re-use and recycling.	a. Work with private and non-profit recycling companies to explore options to address: <ul style="list-style-type: none"> • Backyard waste including compostable materials. • Hard to recycle goods (building materials, computers, furniture, etc.). 	RDN	Short Term
1.5.2 The RDN strongly supports composting of household and garden waste.	b. Continue to provide education on the methods and benefits of composting household and garden waste.	RDN	Ongoing
1.5.3 The RDN will provide collection of all residential food waste starting in 2010 for single family dwellings.	c. Initiate collection of all residential food waste in 2010 for single family dwellings.	RDN	Short Term

Goal 1. Plan and Design with Nature in Mind

1.6 Energy Efficiency

Objectives

- 1.6.1 To reduce GHG emissions through use of energy efficient site planning, building design, operation and maintenance best practices.
- 1.6.2 To have one certified energy efficient commercial/institutional/multi-family building in Bowser Village Centre by 2020.
- 1.6.3 To have one building or site powered solely from renewable energy sources by 2020.
- 1.6.4 To reduce household energy demand by 50% by 2020.

Policies	Related Actions	Who	Time
<p>1.6.1 The RDN shall encourage the application of environmentally friendly and energy efficient best practices such as Leadership in Energy and Environmental Design (LEED) or a suitable equivalent for all buildings and landscaping in Bowser Village Centre.</p> <p>1.6.2 Consider the use of street orientation, building placement and use of shading and solar gain to maximize energy efficiency of buildings and public spaces.</p>	<p>a. Provide educational materials to land owners and developers on the methods and economic and environmental benefits of energy efficient building and site design.</p> <p>b. Use DP's to encourage energy efficient design in commercial, multi-family and institutional buildings.</p>	RDN	Ongoing
<p>1.6.3 The RDN shall encourage the development of shared-use and multi-functional facilities to reduce materials, energy and maintenance costs. Consider combining compatible uses such as libraries, recreation/cultural centres, educational facilities, daycares and clinics in the same building or site.</p>	<p>c. Look for opportunities to promote collaboration amongst different private and public developers and service providers to develop shared-use/ multi-functional facilities.</p>	RDN	Ongoing

3 Policies & Implementation

Goal 1. Plan and Design with Nature in Mind

1.7 Lighting

Objectives

- 1.7.1 To preserve dark night skies as a rural feature in Bowser Village Centre through use of energy efficient outdoor lighting that minimizes glare and light pollution.
- 1.7.2 To use outdoor lighting to create a safe pedestrian experience.

Policies	Related Actions	Who	Time
1.7.1 The RDN shall encourage the use of outdoor lighting including street lighting that enhances the pedestrian environment while conserving energy and preserving darks skies by minimizing light pollution and glare.	a. Use DP's to encourage energy efficient lighting on the exterior of commercial, multi-family and institutional buildings and sites.	RDN	Immediate
1.7.2 The RDN will work with residents and MOTI to establish priorities for street lighting along Highway 19A and in commercial areas of Bowser Village Centre.	b. Request MOTI to provide information on options and costs for energy efficient street lighting on Highway 19A. c. Explore the interest and feasibility of a local service area for providing street lighting in commercial areas of Bowser Village Centre.	RDN MOTI Com	Short Term

Goal 2. Build a safer, more resilient community

2.1 Safety - Crime Prevention

Objectives

- 2.1.1 To ensure that planning, design and maintenance of buildings, public spaces, pathways, roads and landscaping are used to promote healthy community use and reduce opportunities for crime.
- 2.1.2 To achieve a vibrant commercial area with integrated residential uses that promote natural surveillance.

Policies	Related Actions	Who	Time
<p>2.1.1 The RDN will promote the use of building, site and landscaping design to improve public safety on both private and public land.</p> <p>2.1.2 The RDN will encourage the use of Crime Prevention through Environmental Design (CPTED) or similar design techniques.</p>	<p>a. Involve Oceanside RCMP and Citizens on Patrol in review of development proposals and parks and trail planning.</p> <p>b. Encourage Oceanside RCMP and Citizens on Patrol to conduct a safety audit with community groups and other stakeholders.</p> <p>c. Use DP design guidelines to ensure that public safety is addressed in building, site and landscaping design.</p>	RDN RCMP COP	Immediate
<p>2.1.3 The RDN may consider adopting a bylaw to require the maintenance of landscaping and buildings on all properties in Bowser Village Centre to create an attractive built environment and demonstrate community pride.</p>	<p>d. Research options for a building and landscaping maintenance bylaw for Bowser Village Centre.</p>	RDN	Short Term
<p>2.1.4 The RDN shall continue to support the efforts of Citizens on Patrol (COP) and encourage the formation of 'block watch' programs with business and resident participation.</p>	<p>e. Request that RCMP and COP promote 'block watch' programs amongst residents and businesses.</p>	RCMP COP Com LCBA	Short Term
<p>2.1.5 The RDN shall support the formation of a Bowser Village 'beautification' committee to promote ownership of public spaces and streetscapes through landscaping and public art.</p>	<p>f. Encourage the creation of a Bowser Village 'beautification' committee by local community members and organizations.</p>	LCBA Com	Short Term

3 Policies & Implementation

Goal 2. Build a safer, more resilient community

2.2 Disaster Resilience - General

Objectives

- 2.2.1 To increase the resilience of residents to the impacts of emergencies and disasters.
- 2.2.2 To mitigate the impacts of climate change caused by anticipated increases in extreme weather events and sea level rise.

Policies	Related Actions	Who	Time
2.2.1 The RDN shall encourage the use of technologies, design and social practices that enable self-reliance (for example: independent heat sources, rain water harvesting, ability to produce food locally and individual emergency preparedness skills).	<ul style="list-style-type: none"> a. Continue to provide educational materials on ways to improve individual/household resilience to disasters. b. Continue to encourage participation of residents and businesses in emergency preparedness training. 	RDN Com LCBA	Ongoing
2.2.2 The RDN will continue to support the use of the Bowser Legion as a Reception Centre for those evacuated during an emergency/disaster.	<ul style="list-style-type: none"> c. Encourage renovations or redevelopment of the Legion Hall to consider Reception Centre Use. 	RDN RCL	Ongoing
2.2.3 The RDN will encourage the underground placement of electrical and communication cables in all new developments.	<ul style="list-style-type: none"> d. Consider a bylaw to require the underground placement of electrical and communication cables. 	RDN	Short Term
2.2.4 The RDN will collaborate with emergency responders and MOTI to develop evacuation plans for Bowser Village Centre.	<ul style="list-style-type: none"> e. Hold a workshop on evacuation planning with various stakeholders. 	RDN MOTI MOFR RCMP BCAS BHBVFD DBVFD	Ongoing
2.2.5 The RDN will encourage owners and users of the rail corridor to share information and collaborate with Bow Horn Bay and Deep Bay Fire Departments to understand and mitigate risks caused by the transportation of hazardous and heavy goods.	<ul style="list-style-type: none"> f. Request that the Island Corridor Foundation and rail service operators assist Bow Horn Bay and Deep Bay Fire Departments in understanding the risks of transportation of hazardous and heavy goods and involves them in joint planning to respond to emergency situations involving the railway. 	ICF BHBVFD DBVFD	Short Term

Goal 2. Build a safer, more resilient community

2.3 Wildland Interface Fire

Objectives

- 2.3.1 To raise awareness of Interface Fire risk in Wildland Urban Interface (WUI) areas and provide education for residents and land owners to take steps to mitigate risk.
- 2.3.2 To have a development permit area designated for interface fire hazard in place by 2012.
- 2.3.3 To have an established and regularly maintained interface fire buffer around Bowser Village Centre abutting Crown and private forested lands by 2015.

Policies	Related Actions	Who	Time
2.3.1 The RDN will work with MOFR, ILMB and MOE to establish Interface Fire buffers and fuel management zones on Crown lands.	a. Request MOFR, ILMB and MOE to develop a fuel management strategy for forested lands adjacent to Bowser Village Centre including establishing fire breaks/buffers.	RDN MOFR ILMB MOE	Short Term
2.3.2 Designate areas to be included in an Interface Fire Development Permit Area in order to reduce the risk of interface fires	b. Request assistance from MOFR to determine appropriate areas and guidelines to be included in a Interface Fire Hazard Development Permit Area for Bowser Village Centre. c. Review information and recommendations from the <i>Bow Horn Bay and Deep Bay Community Wildfire Protection Plans</i> .	RDN MOFR BHBVFD DBVFD	Short Term
2.3.3 Where appropriate the RDN supports the placement of fire breaks (with adequate room for access by emergency vehicles) within parks and trails.	d. Work with MOTI and MOFR to integrate planning for parks and trails with interface fire safety in mind.	RDN POSAC MOFR MOTI	Short Term
2.3.4 The RDN will support the efforts of Bow Horn Bay and Deep Bay Fire Departments and MOFR in providing public education and awareness of interface fire risk and FireSmart mitigation techniques.	e. Provide all development applicants with information on FireSmart techniques and the <i>Bow Horn Bay and Deep Bay Community Wildfire Protection Plans</i> .	MOFR BHBVFD DBVFD	Ongoing

3 Policies & Implementation

Goal 2. Build a safer, more resilient community

2.4 Climate Change

Objectives

- 2.4.1 To build greater understanding of the impact of individual energy consumption on GHG emissions and climate change (through transportation, housing, employment and recreational choices) and encourage individual actions to reduce GHG emissions.
- 2.4.2 To raise awareness of the impacts of climate change and ways to mitigate them.
- 2.4.3 To ensure that building and sites are designed to cope with extreme storm events.
- 2.4.4 To ensure that sea level rise is taken into account when reviewing coastal development.

Policies	Related Actions	Who	Time
<p>2.4.1 The RDN will provide information about the effect of individual and collective human activities on climate change and encourage individuals and organizations to take ownership by changing behaviours and practices including:</p> <ul style="list-style-type: none"> • Reducing vehicle trips • Supporting local food production • Switching to renewable energy sources • Increasing energy efficiency of buildings • Reducing demand for energy, water and other resources • Reducing waste 	<ul style="list-style-type: none"> a. Continue to provide educational material and promote awareness of the individual and community impacts on climate change. b. Continue to implement land use and alternative transportation plans that support individuals in making lifestyle changes to reduce GHG emissions. c. Review RDN Bylaws with the intent of removing barriers. 	RDN Com	Short Term
<p>2.4.2 The RDN will provide information about the anticipated impacts of climate change upon:</p> <ul style="list-style-type: none"> • Individuals and their homes • The build environment and infrastructure • The natural environment including physical processes (e.g. coastal and riparian erosion) 	<ul style="list-style-type: none"> d. Review information on anticipated impacts of sea level rise and use to update DPAs, zoning, and subdivision servicing bylaws. e. Promote the use of 'green' building and infrastructure as an effective approach to cope with extreme variations in storm water/ drought. 	RDN	Short Term

Policies	Related Actions	Who	Time
2.4.3 The RDN will ensure that it considers sea level rise and coastal erosion in the review of subdivisions and rezoning.	f. Ensure that the Natural Hazards DPA Guidelines are reviewed and updated in light of information regarding anticipated sea level rise Bowser Village Centre.	RDN	Short Term

Goal 3. Be More Inclusive and Accountable

3.1 Participation in Planning Processes

Objectives

3.1.1 To increase opportunities for meaningful participation in planning processes.

3.1.2 To ensure that planning processes are clear and transparent.

3.1.3 To provide a range of approaches to working with diverse community members so that the needs of all are considered (children, youth, seniors, those with different abilities, limited access to transportation/childcare).

Policies	Related Actions	Who	Time
3.1.1 The RDN shall continue to provide opportunities for the community to guide development by involving community members in parks and development planning.	a. Continue to provide opportunities for the community to be involved in land use planning. b. Continue to engage Bowser residents in parks and trails planning and development.	POSAC RDN	Ongoing
3.1.2 The RDN shall consider the feasibility of creating a Bowser Village Centre Planning Committee to provide input on rezoning, subdivision applications/development proposals.	c. Review the resources required to create and maintain a Bowser Village Centre Planning Committee.	RDN	Short Term
3.1.3 The RDN will ensure that a clear and ongoing planning process is followed that: <ul style="list-style-type: none"> • respects the direction of the Bowser Village Plan • is inclusive and responds to needs and priorities identified by the community • Takes into account what is happening outside of Bowser Village Centre 	d. Request community feedback and input on planning processes and adjust approaches as necessary. e. Use the Bowser Village Plan to review and guide future development in Bowser Village Centre. f. Consider the influence and impact of land use activities in Bowser Village Centre upon Area 'H' and the RDN as a whole and vice versa.	RDN	Ongoing

3 Policies & Implementation

Goal 3. Be More Inclusive and Accountable

3.2 Costs and Efficiency

Objectives

- 3.2.1 To consider the financial implications of each rezoning and subdivision application on the existing residents and businesses in Bowser Village Centre.
- 3.2.2 To consider the broader social and environmental costs of development on current and future generations.

Policies	Related Actions	Who	Time
3.2.3 The RDN will ensure that planning and development proposals for Bowser Village Centre takes into account environmental, economic and social impacts on other Village Centres in Electoral Area 'H' and the Regional District as a whole.	a. Develop a checklist of sustainability criteria for the evaluation of development proposals.	RDN MOTI	Short Term
3.2.4 The RDN will ensure that developers bear the costs of infrastructure improvements and requirements for new development.	b. Use DP's and zoning and subdivision bylaws to ensure that developers pay costs related to the installation or upgrade of facilities for the benefit of their lands.	RDN BHBFD DBFD	Ongoing
3.2.5 Rezoning to increase building height which result in the need to purchase additional firefighting equipment will require the applicant to contribute towards the additional costs.	c. Continue to refer rezoning applications to the relevant local fire department and do not approve requests for additional building heights unless fire protection can be met by existing fire department equipment or the developer pays for extra equipment and facilities needed. d. Consider integrating third floors within attics/rooflines so no overall increase in height is required to accommodate 3 storeys.	RDN DBID BHBVFD DBVFD BWD	Ongoing

Goal 3. Be More Inclusive and Accountable

3.3 Access to Recreation

Objectives

- 3.3.1 To increase and maximize use of existing recreational amenities in Area 'H' prior to considering new opportunities in Bowser Village Centre.
- 3.3.2 To ensure that the needs of children, youth, families and seniors are considered in planning and programming recreational spaces and programs.

Policies	Related Actions	Who	Time
3.3.1 The RDN shall ensure that recreational opportunities are accessible and adequate to meet a diversity of needs while ensuring the use of existing community facilities is maximized.	a. Take into account the actual and potential use of existing community amenities and facilities in Area 'H' and the RDN prior to supporting proposals for new community amenities and facilities in Bowser Village Centre.	RDN	Ongoing
3.3.2 The RDN shall strive to provide passive and active recreational opportunities to meet community needs.	<ul style="list-style-type: none"> b. Work with a diversity of community groups including Bowser Elementary to discuss priorities for recreation, parks and open space. c. Promote use of 'Universal Design' for parks, open space and recreational facilities. 	RDN POSAC LRC	Short Term

3 Policies & Implementation

Goal 3. Be More Inclusive and Accountable

3.4 Housing Diversity and Affordability

Objectives

- 3.4.1 To increase the range of housing types, tenures and affordability in Bowser Village Centre.
- 3.4.2 To provide 40 units of seniors housing in Bowser Village Centre by 2020.
- 3.4.3 To have 15% of dwelling units meeting the CMHC definition of affordable housing by 2020.

Policies	Related Actions	Who	Time
3.4.1 The RDN shall implement the recommendations of the 2009 Housing Needs and Affordability study that address the needs of Bowser Village Centre.	a. Produce a staff report on which recommendations of the 2009 <i>Housing Needs and Affordability</i> study should be implemented in Bowser Village Centre.	RDN	Short Term
3.4.2 The RDN will encourage a diversity of housing types and tenures that provide a range of affordability and are adaptable to different life stages.	b. Consider incentives for providing affordable housing within new and existing developments.	RDN	Ongoing
3.4.3 Promote the concept of 'Universal Design' particularly for multi-family residential, commercial and public areas.	c. Provide developers, land owners and businesses with information on 'Universal Design'. d. Consider 'Universal Design' in the review of development applications.	RDN	Short Term
3.4.4 The RDN will encourage affordable housing (including seniors housing) to be integrated with the rest of the community and located close to shops, services, transit and public amenities.	e. Review development applications to ensure that affordable housing (including seniors housing) is located close to shops, services, transit and public amenities.	RDN	Ongoing
3.4.5 The RDN supports secondary dwelling units in all residential areas within Bowser Village Centre.	f. Include secondary suites as a permitted use within single family dwellings in Bowser Village Centre. g. Review and amend Zoning Bylaw 500.	RDN	Short Term
3.4.6 The RDN supports establishment of a seniors housing facility on the two Crown lots leased for that purpose. ⁶	h. Support the Bowser Seniors Housing Society in the process towards establishing a seniors housing facility.	RDN Com	Ongoing

⁶ Bylaw 1335.06, Adopted December 12, 2017

<p>3.4.7 Rezoning of LOT A, DISTRICT LOT 85, NEWCASTLE DISTRICT, PLAN EPP67156 at the corner of Crosley Road and Highway 19A will only be supported if a road is constructed to access the Seniors Housing site described in 3.4.6 above.⁷</p>	<p>i. Ensure that the road is constructed as a condition of any rezoning. This lot was taken from the Future Use Area and added to the Commercial Mixed Use designation of the Bowser Village Plan in 2017, on the condition that prior to rezoning, the owner would construct, at their cost, a road to access the future Seniors Housing on adjacent Crown lots.</p>	<p>RDN</p>	<p>Ongoing</p>
---	--	------------	----------------

Goal 4. Increase Community Pride and Ownership

4.1 Vibrant Social Spaces

Objectives

- 4.1.1 To foster community pride and ownership by clearly defining Bowser Village Centre as distinct, unique and attractive place.
- 4.1.2 To ensure that the design, scale and siting of new buildings, streets and open spaces reflect the rural and natural character of Area H, while still allowing room for innovation.
- 4.1.3 To recognize and encourage the development of arts and culture in Bowser Village Centre.
- 4.1.4 To have the entrances/gateways to Bowser Village Centre clearly defined by 2015.
- 4.1.5 To have a park with views of the ocean for residents and visitors located in the area near Georgia Park.
- 4.1.6 To have at least one well-defined, attractive, outdoor gathering space central to shops and services near Bowser Village Centre’s commercial area (Magnolia Court and adjacent businesses) by 2015.
- 4.1.7 To have a children’s play area incorporated into a central outdoor gathering space near Magnolia Court by 2015.

Policies	Related Actions	Who	Time
<p>4.1.1 The RDN will use development permits and the re-zoning process to ensure that the design, scale and siting of buildings, streets and open spaces reflects community objectives for an aesthetically pleasing environment in Bowser Village Centre.</p>	<p>a. Follow Village Plan policies and development permit guidelines when reviewing development applications.</p>	<p>RDN</p>	<p>Ongoing</p>

⁷ Bylaw 1335.06, Adopted December 12, 2017

3 Policies & Implementation

<p>4.1.2 The RDN will work with land-owners and residents to create well-defined, attractive, outdoor gathering spaces in Bowser Village Centre. This may include work on community gardens, a village green, parks space, and public art. Key areas identified by the community for parks and/ community open space include:</p> <ul style="list-style-type: none"> • A waterfront park located between Coburn Road and Henry Morgan Drive (see section 6.2 Beach and Waterfront Access) • Community gathering space and a children’s play area in a central area near Magnolia Court • An ocean view park for residents and visitors near Georgia Park <p>See Map 4.1.2 for general locations</p>	<p>b. Work with residents, business and land-owners to identify priorities for outdoor gathering spaces in Bowser Village Centre that are linked to a wider network of pedestrian pathways and parks.</p> <p>c. During rezoning, subdivision and development processes, use development permits and park dedications/developer contributions to create public outdoor spaces in areas identified as priorities for the community.</p>	<p>RDN POSAC LCBA</p>	<p>Ongoing</p>
<p>4.1.3 The RDN will pursue opportunities to strengthen social networks and community spirit through participation in public projects to enhance Bowser Village Centre.</p>	<p>d. As appropriate, work with Area ‘H’ POSAC, Qualicum First Nation, residents and community organizations to collaborate on planning, designing and implementing public projects.</p>	<p>RDN QFN POSAC Com LCBA</p>	<p>Ongoing</p>
<p>4.1.4 The RDN will encourage the design of new developments, public open spaces, gateways and streetscapes to reflect the natural and cultural heritage of Bowser by incorporating one of the following themes:</p> <ul style="list-style-type: none"> • Lighthouse Country • First Nations History • Post 1900 Historical Themes (logging, fishing and shellfish aquaculture) • Connection to water (aquifers, surface water, Thames Creek and Ocean) • West Coast style design 	<p>e. Work with Qualicum First Nation, residents and community organizations to collaborate on planning, designing and implementing public projects.</p> <p>f. DP guidelines.</p>	<p>RDN POSAC LCBA QFN Com</p>	<p>Ongoing</p>
<p>4.1.5 The following Gateways are identified in this plan:</p> <ul style="list-style-type: none"> • Southern Gateway (on Highway 19A at the Mc Coll Road intersection) • Northern Gateway (on Highway 19A at the Crosley Road intersection) 	<p>g. Encourage the community, business owners and MOTI to work together to plan and improve gateway areas.</p>		<p>Short Term</p>

<ul style="list-style-type: none"> • Ocean Gateway (near where Bowser Road meets the ocean) • At regional trail entrances to Bowser Village Centre 				
4.1.6	The RDN supports the installation of welcoming signs, landmark features and landscaping to beautify gateway areas. Gateway design should be consistent with the overall design themes for Bowser Village Centre.	h. Provision of gateway structures and landscaping can be considered a community amenity. i. Encourage landmark building design, public art and open space in gateway areas.	RDN POSAC LCBA MOTI	Short Term
4.1.7	The RDN will explore the options and feasibility for developing a drop in/cultural centre with developer contributions.	j. Review feasibility of using developer contributions for a drop in/cultural centre.	RDN	Long Term

Goal 4. Increase Community Pride and Ownership

4.2 Crown Land

Objectives

4.2.1 To preserve Crown land in and adjacent to Bowser Village Centre for long-term community benefit.

Policies	Related Actions	Who	Time	
4.2.1	The RDN will encourage the Provincial Government to work collaboratively on the management and planning for Crown lands within and adjacent to Bowser Village Centre.	a. Request that ILMB, MOFR and MOE involve the RDN, First Nations and the wider community in land use management and planning on Crown lands adjacent to Bowser Village Centre.	RDN ILMB MOFR MOE QFN Com MOTI	Short Term
4.2.2	The RDN will explore the demand for, and feasibility of, acquiring Crown land within the Bowser Village Centre Boundary for future community use (including seniors and affordable housing projects, schools, parks, recreational facilities, wastewater treatment facilities).	b. Continue discussions with ILMB with regard to options for acquiring Crown land for community use. c. Provide Area 'H' residents with estimated costs and timelines for making an application for Crown land.	RDN ILMB	Short Term

3 Policies & Implementation

<p>Goal 5. Increase Sustainable Economic Activity</p> <p>5.1 Diverse Rural Village Economy</p> <p>Objectives</p> <p>5.1.1 To diversify the local economy through the development of a Village Centre with a mix of land uses.</p> <p>5.1.2 To ensure that proposals for commercial and commercial service/light industrial development are evaluated in relation to local needs.</p> <p>5.1.3 To support food security by providing opportunities for local food production, marketing and consumption utilizing organic methods and/or heritage breeds and varieties.</p> <p>5.1.4 To ensure that Bowser Village Centre is promoted as a hub for small scale rural enterprises.</p>

Policies	Related Actions	Who	Time
5.1.1 The RDN is strongly encouraged to work with local business networks and associations (such as Lighthouse Country Business Association) to develop an economic strategy for Bowser Village Centre.	a. Request assistance from LCBA, Community Futures and other relevant agencies to develop an economic strategy.	RDN LCBA Com. Futures Com	Short Term
5.1.2 The RDN will encourage local businesses and business organizations to promote the concept of 'Buy In Bowser' to support local retail shops and services.	b. Assist the LCBA in providing information on the benefits of supporting local retail and other services.	RDN LCBA Com	Ongoing
5.1.3 The RDN will support the location of home based and cottage industries that are compatible with residential uses throughout residential areas in Bowser Village Centre.	a. Review and amend the zoning bylaw as necessary.	RDN	Short Term
5.1.4 The RDN will promote and encourage heritage and/or organic local food production and distribution by removing barriers to the establishment of farmers markets, processing and distribution facilities, community gardens, roof top gardens, greenhouses and productive/edible landscaping.	b. Review the zoning and building bylaws with the view of removing requirements that pose obstacles to establishing farmers markets, community gardens and greenhouses and productive/edible landscaping. c. Request that the RDN's Agricultural Advisory Committee provide advice on promoting and encouraging food security initiatives.	RDN	Short Term

Goal 6. - Connect people and places in ways that promote safe, enjoyable and healthy movement

6.1 Encouraging Active Transportation

Objectives

- 6.1.1 To increase healthy, energy efficient modes of transportation and reduce private vehicle use.
- 6.1.2 To see visible improvements in the safety, access and attractiveness of streetscapes for pedestrians and other traffic in Bowser Village Centre by 2015.
- 6.1.3 To have safe pedestrian and cycling paths that connect Bowser Village Centre to outside neighbourhoods along the road right of way along Highway No. 19A by 2020.
- 6.1.4 To have a speed limit of 50 km established on Highway No. 19 A between Crosley Road and McColl Road intersections by 2015.
- 6.1.5 To have at least two clearly marked pedestrian crossing areas across Highway No. 19A near Magnolia Court and Georgia Park commercial areas in Bowser Village Centre by 2015.
- 6.1.6 To maximize the use of existing regional trail and rail trail corridors for active transportation and recreational use.

Policies	Related Actions	Who	Time
6.1.1 The RDN supports undertaking a Built Environment and Active Transportation (BEAT) assessment and plan for Bowser Village Centre.	a. Seek funding for a BEAT study of Bowser Village Centre and incorporate results in an Active Transportation plan for Bowser. b. Request that MOTI assists with a BEAT assessment for Bowser Village Centre.	RDN MOTI	Short Term
6.1.2 The RDN strongly encourages the use of existing regional and rail trail corridors for passive and active transportation and recreation.	c. Continue working on the development of regional and rail trail corridors.		Ongoing
6.1.3 The RDN encourages the development of an Active Transportation component in all new road developments and retrofit of existing roads-as identified in the Electoral Area 'H' Active Transportation Plan, 2017. ⁸	d. Continue to work with MOTI to pursue Active Transportation on existing and undeveloped road right of ways.		Ongoing

⁸ Bylaw 1335.06, Adopted December 12, 2017

3 Policies & Implementation

<p>6.1.4 The RDN shall work with MOTI and the community to implement the Electoral Area 'H' Active Transportation Plan, 2017 and consider⁹:</p> <ul style="list-style-type: none"> • Separate paths/sidewalks for pedestrians, cyclists and scooters, especially along Highway No. 19A • Slowing traffic to 50 km/hour before entering Bowser Village Centre by posting signage and implementing traffic calming at Crosley and Mc Coll Road intersections on Highway No. 19A • Pedestrian crossings across Highway No. 19A to facilitate safe walking access between residential and commercial areas • Safe pedestrian and cycling routes for Bowser Elementary School children • Minimizing entrances and exits onto Highway No. 19A through the use of collector/feeder roads or shared driveways 	<p>e. Continue discussions with MOTI to achieve Traffic/pedestrian safety objectives.</p> <p>f. Involve local community groups like LCBA in planning and discussions.</p>	<p>RDN MOTI LCBA</p>	<p>Short Term</p>
<p>6.1.5 The RDN will encourage the provision of access and facilities for bicycles, scooter, wheelchairs and strollers in commercial, multi-family, institutional and recreational areas.</p>	<p>g. Review options and encourage developers and business owners to provide access and facilities for bicycles, scooter, wheelchairs and strollers.</p>	<p>RDN Com</p>	<p>Ongoing</p>
<p>6.1.6 The RDN will investigate opportunities to reduce parking requirements for residential and commercial developments that provide car sharing co-operatives and other sustainable, affordable transportation initiatives.</p>	<p>h. Review options and update Bylaw No.500 as required.</p>	<p>RDN</p>	<p>Ongoing</p>

⁹ Bylaw 1335.06, Adopted December 12, 2017

Goal 6. - Connect people and places in ways that promote safe, enjoyable and healthy movement

6.2 Beach and Waterfront Access

Objectives

- 6.2.1 To provide new and enhance existing beach access within Bowser Village Centre by 2015.
- 6.2.2 To establish a waterfront park in Bowser Village Centre with safe pedestrian access to residential and commercial Areas by 2020.

Policies	Related Actions	Who	Time
6.2.1 The RDN will work with community members to develop priorities to improve existing beach access at Henry Morgan, Coburn, Bowser and Midland Roads and to explore opportunities for new public beach access in the Bowser Village Centre Plan area.	<ul style="list-style-type: none"> a. Work with the community and land owners to determine priorities for improving existing beach access at Coburn, Bowser and Midland Roads. b. Work with the community and land owners to identify future beach access in the Bowser Village Centre as part of a broader system of trails and parks. 	RDN POSAC Com	Short Term
6.2.2 The RDN will work towards establishing a waterfront park between Coburn Road and Henry Morgan Drive.	<ul style="list-style-type: none"> c. Explore opportunities to acquire land for a waterfront park as part of future development of waterfront lots between Coburn and Henry Morgan Drive. d. The RDN shall consider options such as park dedication through subdivision or community amenity provision through rezoning. 	RDN POSAC Com	Short Term
6.2.3 The use of shoreline stabilisation measures on Crown Foreshore, in a manner that obstructs pedestrian access to and along public beaches or foreshore areas, shall not be supported.	<ul style="list-style-type: none"> e. Work with property owners, DFO, ILMB and MoE to develop solutions to beach stabilisation issues that do not block public access along Crown Foreshore. 	RDN ILMB MoE Com	Ongoing

3 Policies & Implementation

Goal 6. - Connect people and places in ways that promote safe, enjoyable and healthy movement

6.3 Transit

Objectives

- 6.3.1 To provide viable, sustainable and affordable alternatives to private vehicle use within Bowser and between other neighbourhoods and larger urban centres.
- 6.3.2 To have a passenger rail service at least twice a day to Bowser by 2025.
- 6.3.3 To have a transit service at least twice a day between Bowser and other areas established by 2015.
- 6.3.4 To have a transit and rail stop established in close proximity to each other and integrated with commercial areas close to the railway in Bowser Village Centre.

Policies	Related Actions	Who	Time
6.3.1 The RDN will work with the community, BC Transit and the Island Corridor Foundation to explore priorities and implement viable options for rail and bus transit between Bowser Village Centre and other areas.	<ul style="list-style-type: none"> a. Continue to work with BC Transit to study costs and viable options for providing bus transit to Bowser Village Centre. b. Invite the community to provide input on decisions regarding costs, scheduling and location of stops for passenger rail and bus transit. 	RDN BCT Com ICF	Ongoing
6.3.2 The RDN will request that the Island Corridor Foundation designate a passenger rail stop close to commercial areas in Bowser Village Centre and to provide service at least twice daily.	<ul style="list-style-type: none"> c. Continue to engage Island Corridor Foundation with regard to designating a rail passenger stop and providing regular rail passenger services to Bowser Village Centre. 	RDN ICF	Ongoing
6.3.3 The RDN will support and encourage the location of rail and bus transit stops in close proximity to each other and within walking distance to the commercial areas of Bowser Village Centre.	<ul style="list-style-type: none"> d. Facilitate the coordination of bus and rail facility planning and encourage coordination of schedules where possible. 	RDN ICF BCT	Short Term
6.3.4 The RDN will support the integration of rail and transit stops within commercial developments.	<ul style="list-style-type: none"> e. Revise Bylaw No. 500 to allow provision for a rail and bus station within suitable commercial areas. Consider integrating rail platforms with coffee shops, art galleries, museums and other appropriate uses. 	RDN	Short Term

Section 4

Table of Contents

4.1 Land Use Concept

- 4.1.1 Legend
- 4.1.2 Land Use Concept Map
- 4.1.3 Mobility Map
- 4.1.4 Height Map
- 4.1.5 Density Targets

4.2 Land Use Designations

- 4.2.1 Commercial - Mixed Use
- 4.2.2 Commercial - Tourist
- 4.2.3 Residential - High Density
- 4.2.4 Residential - Medium Density
- 4.2.5 Civic and Cultural
- 4.2.6 Park and Open Space/Conservation Area
- 4.2.7 Future Use Area



4 Land Use Concept & Designations







4.1 Land Use Concept

This section describes the overall land use concept for Bowser Village Centre, and the intent, uses and character of the different land use designations. The land Use Designations and key features reflect the work that was produced during the Bowser Charette (May 2009) and subsequent feedback from the Advisory Group and wider community (see Appendix B).

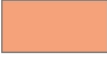





It is acknowledged that this concept plan will need to be revisited over time to support sustainable development and changing community needs/priorities.

4.1.1 LEGEND









Land Uses

	Civic and Cultural
	Com Mixed Use
	Com Tourist
	Future Use Area
	Park and Open Space
	Residential High Density
	Residential Medium Density

Features

	Future Train & Bus Station		Railway
	General Future Park Area		Gateways
	Desired Cultural Centre		Beach Access

Mobility

	Potential Rail Trail Corridor
	Planned Regional Trail Corridor
	Existing Regional Trail Corridor
	Hwy 19A Major Road
	Existing Secondary Road
	Existing Residential Road
	Potential Future Secondary Road
	Potential Future Residential Road

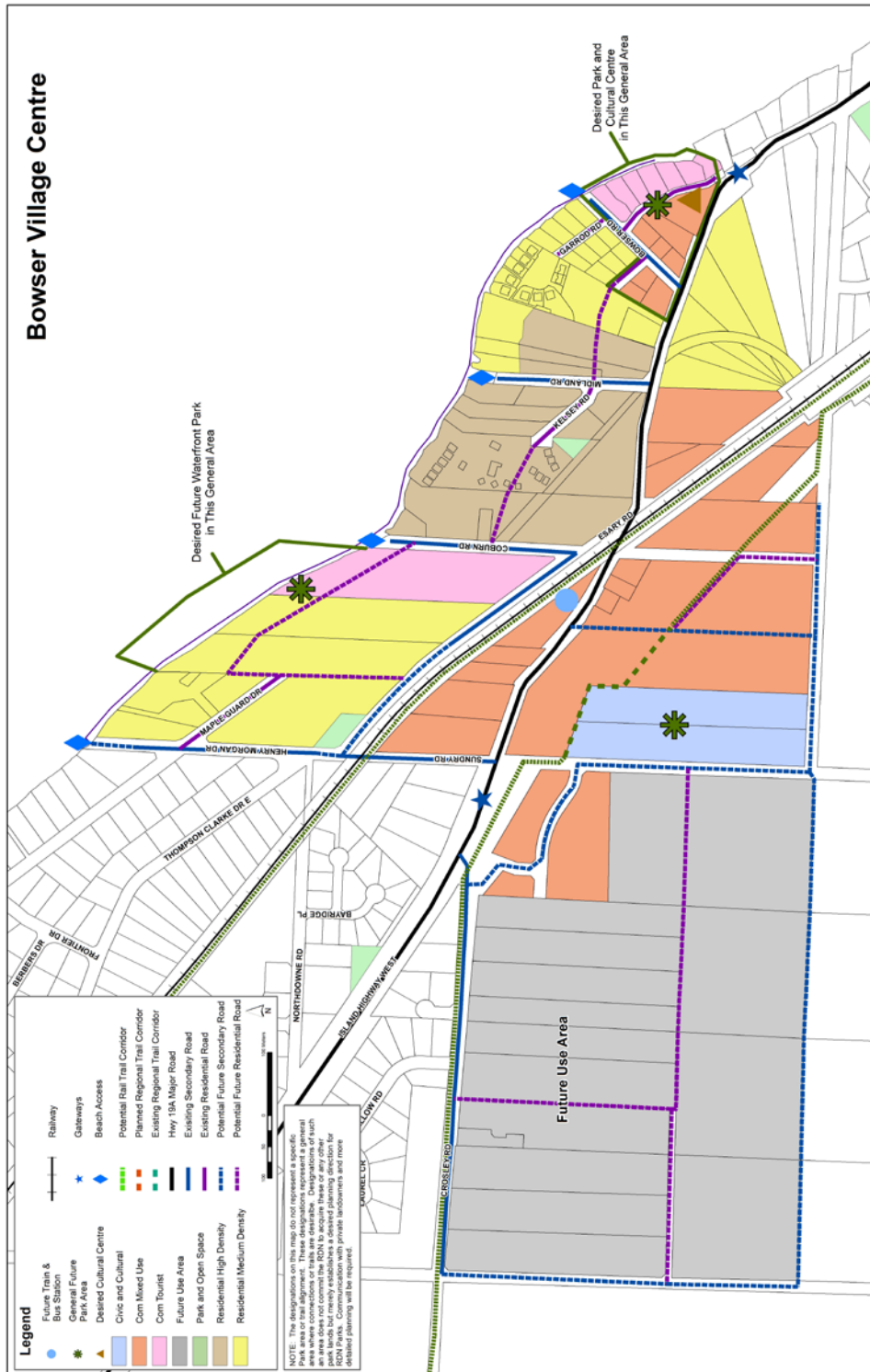

10

¹⁰ Bylaw 1335.06, Adopted December 12, 2017

4 Land Use Concept & Designations

4.1.3 Proposed Mobility Map

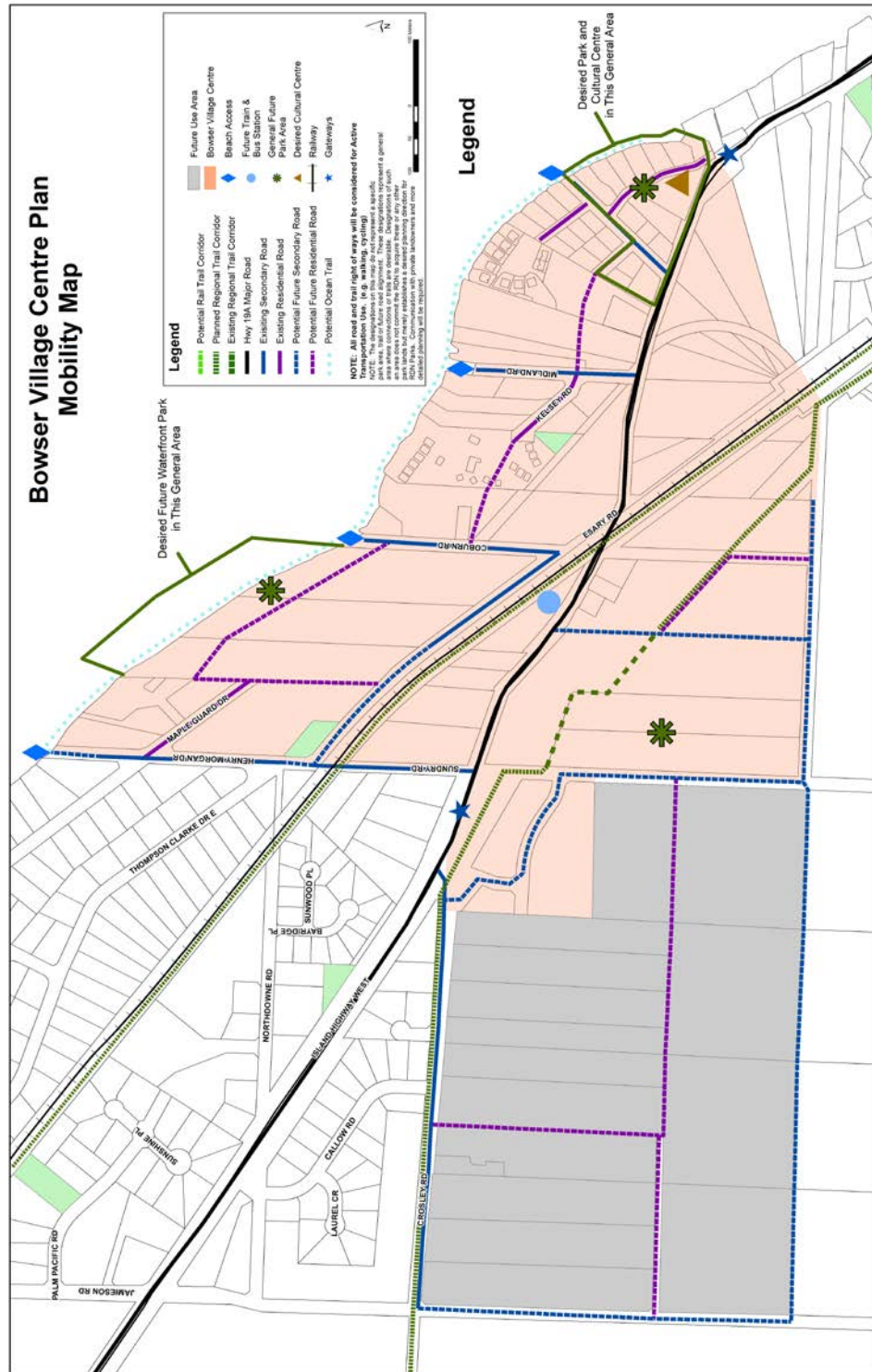

11

¹¹ Bylaw 1335.06, Adopted December 12, 2017

Proposed Building Height Map 4.1.4

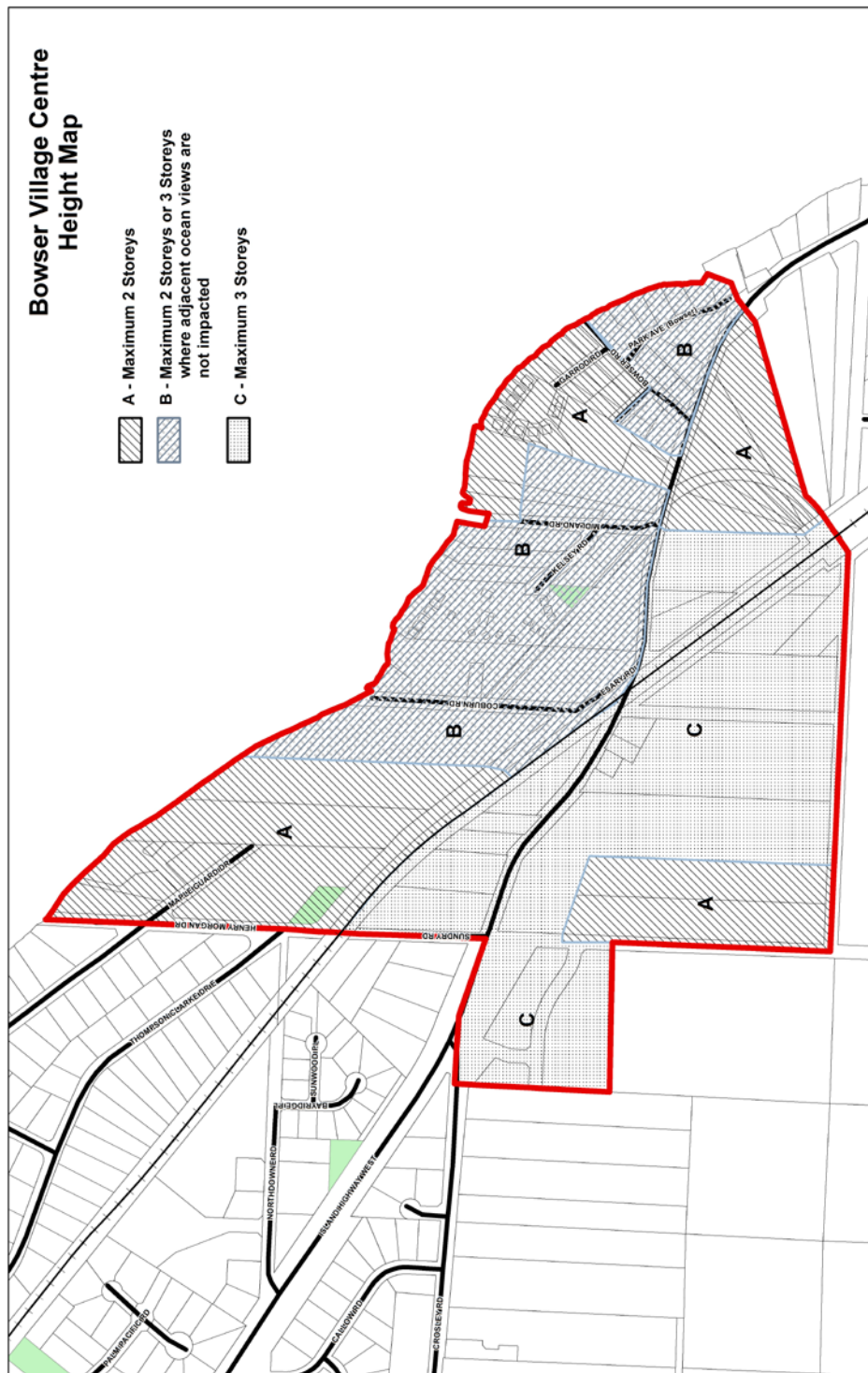

12

¹² Bylaw 1335.06, Adopted December 12, 2017

4 Land Use Concept & Designations

4.1.5 Proposed Density Targets

Density Targets for Affordable Transit

25 units per hectare (10 units per acre) is a commonly agreed upon level of density to achieve economically viable transit service.

This level of density can also support a range of retail, service and employment opportunities within close walking distance.



Water & Wastewater

Achieving Density Targets will require the establishment of economically viable and environmentally sensitive forms of wastewater treatment.

Applications for rezoning will be required to provide written confirmation from Water Districts that there is sufficient water to service proposed developments.

Gradual Growth

It is anticipated that future development in Bowser Village Centre will take place gradually over the next 10-50 years.

Density Targets

Density "Targets" have been set in this plan in order to help achieve a compact, complete Village Centre that meets the sustainability principles and goals outlined in this plan by making more efficient use of land and resources.

Accommodating a higher number people in a concentrated area reduces the environmental impact of development compared to accommodating the same number of people in low density development over a larger area of land.

These are targets to aim for rather than rigid requirements. Targets represent upper limits that will be used to guide future applications for changes in zoning.

Current residential density within the original Bowser Village Centre boundary is 1.6 units per hectare (0.6 units per acre).

This plan sets average residential density targets for lands within the original Bowser Village Centre as follows:

- 20 units per hectare (8 units per acre) by 2025; and
- 30 units per hectare (12 units per acre) by 2040.

The residential density targets included in the individual land use designations are higher than the average density targets for the whole area. In order to work towards reaching the average density targets, higher densities need to be allowed in certain areas to take into account non-residential land uses within the Village Centre.

See the table overleaf for an estimate of the number of units and potentially people that might be reached with different residential density targets in land use designations where residential use is allowed.

Proposed Density Targets 4.1.5

Figure 4.1.5 Density Estimates

Combined target densities for the different land use designations allow the possibility of reaching average targets for 20 & 30 upha – NOTE ALL AREAS & CALCULATIONS ARE APPROXIMATE & FIGURES HAVE BEEN ROUNDED UP FOR CONVENIENCE				
Land Use Designation that permits Residential	Residential Density Targets units/hectare	Area hectares	Estimated units based on reaching Density Targets* **	More realistic estimate of units if Com-Mixed Use and Civic include other uses & reach only 50% of target Residential Density
Civic	35 upha	4 ha	134	67
Com-Mixed Use	35 upha	16 ha	567	284
Com-Tourist	10 upha	5 ha	49	49
Res-High	45 upha	9 ha	419	210
Res-Medium	35 upha	16 ha	567	283
Total Estimated Units			1736 units	893 units
Estimated Population based on 2.1 people/unit			3645 people	<u>1875 people</u>

Number of units needed to meet the Average Density Targets of 20 upha =1016 units & 30 upha =1523 units

Reaching the maximum target densities for each land use could potentially produce up to 1736 residential units.

However, the reality of demand for other non-residential land uses, setbacks, costs of wastewater treatment etc. make 893 residential units a more likely estimate for Bowser over the next 30+ years.

* These are gross calculations and do not include limits on density based on meeting requirements for setbacks, parking, roads etc. that could reduce estimates by 20%.

** Reaching density targets will depend on wastewater treatment options.

4 Land Use Concept & Designations

THIS PAGE INTENTIONALLY BLANK

Land Use Designations 4.2

This section provides details of the intended uses and guidelines for each of the land Use Designations.

The Bowser Village Centre Development Permit Area Guidelines in Section 5 must also be reviewed in conjunction with this section.

Land Use Designations

- 4.2.1 Commercial - Mixed-Use
- 4.2.2 Commercial - Tourist
- 4.2.3 Residential - High Density
- 4.2.4 Residential - Medium Density
- 4.2.5 Civic and Cultural
- 4.2.6 Park and Open Space/Conservation Area
- 4.2.7 Future Use Area

4 Land Use Concept & Designations

4.2.1 Commercial Mixed Use

Intent

The Commercial Mixed-Use designation is a key component of building a 'compact and complete' Village Centre in Bowser that provides opportunities to 'live, work, learn and play'. This designation is intended to encourage the development of a vibrant commercial area with a complementary mix of village scale retail, office, services, residential, institutional and public uses designed to meet local housing, service, employment and social needs. Commercial service/light industrial uses will be considered in this designation where they are compatible with surrounding uses. Residential units that provide opportunities to live in close proximity to services, employment and transit are encouraged in this use.

There will be an emphasis on uses that are compatible with rural village life and that do not negatively impact the environment, especially ground and surface water.

Land Uses

The types of village scale uses that are supported in the Commercial Mixed-Use designation include but are not limited to:

- Retail stores
- Offices
- Multi-unit residential
- Seniors housing
- Affordable housing
- Live work units (1 per business)
- Care facilities
- Cultural and leisure facilities
- Sit-down cafes and restaurants
- Financial institutions
- Personal services such as hair salons and spas
- Educational/training facilities
- Public open space
- Art Galleries
- Libraries
- Temporary outdoor markets
- transit (railway station/platform, railway, bus station)

The following types of commercial service/light industrial uses will be considered where they are compatible with surrounding uses. These include but are not limited to:

- Wood working
- Hardware stores/building supply centres
- High technology research and manufacturing
- Printing, publishing and distribution
- Recycling facilities
- Garden centres
- Equipment rentals

Businesses/ uses are only permitted under the following conditions:

- Noise, odour, vibration, heat, high illumination levels or waste generated by the business are not disruptive to adjacent uses.
- Operations do not compromise surface and ground water quality and quantity.
- Operations do not compromise air quality.

Building Arrangement

- Retail uses at street
- Residential uses at or above street level when associated with the Seniors Housing, Affordable Housing or Core facilities land uses.
- in combined residential and commercial developments, residential uses above street
- Office uses at and above street

Building Height

See Map 4.1.4

Building Types

- Apartments above retail or office use
- Clustered multi-unit residential developments adjacent to retail or office use
- Attached or stacked town houses when associated with a retail or office use.

Target Density

35 Units per hectare (14 units per acre) by 2040

Orientation

Focus buildings to face the street

Parking

On street, behind buildings or underground

Access

Discourage direct vehicular access to Highway No. 19A.
Encourage use of side streets, collector roads or shared driveways.

Pedestrian & Cycling Access

Promote pedestrian, scooter and cycling linkages.
Provide cycling and scooter parking/racks.

Features

Public squares/ courtyards, green space, seating areas, outdoor cafes, restaurants with patios. Green roofs, decks, balconies overlooking streets / views. Walkways sheltered by awnings, canopies or pergolas.

See DPA Guidelines for further direction

Image of Mixed Uses in Bowser Village Centre

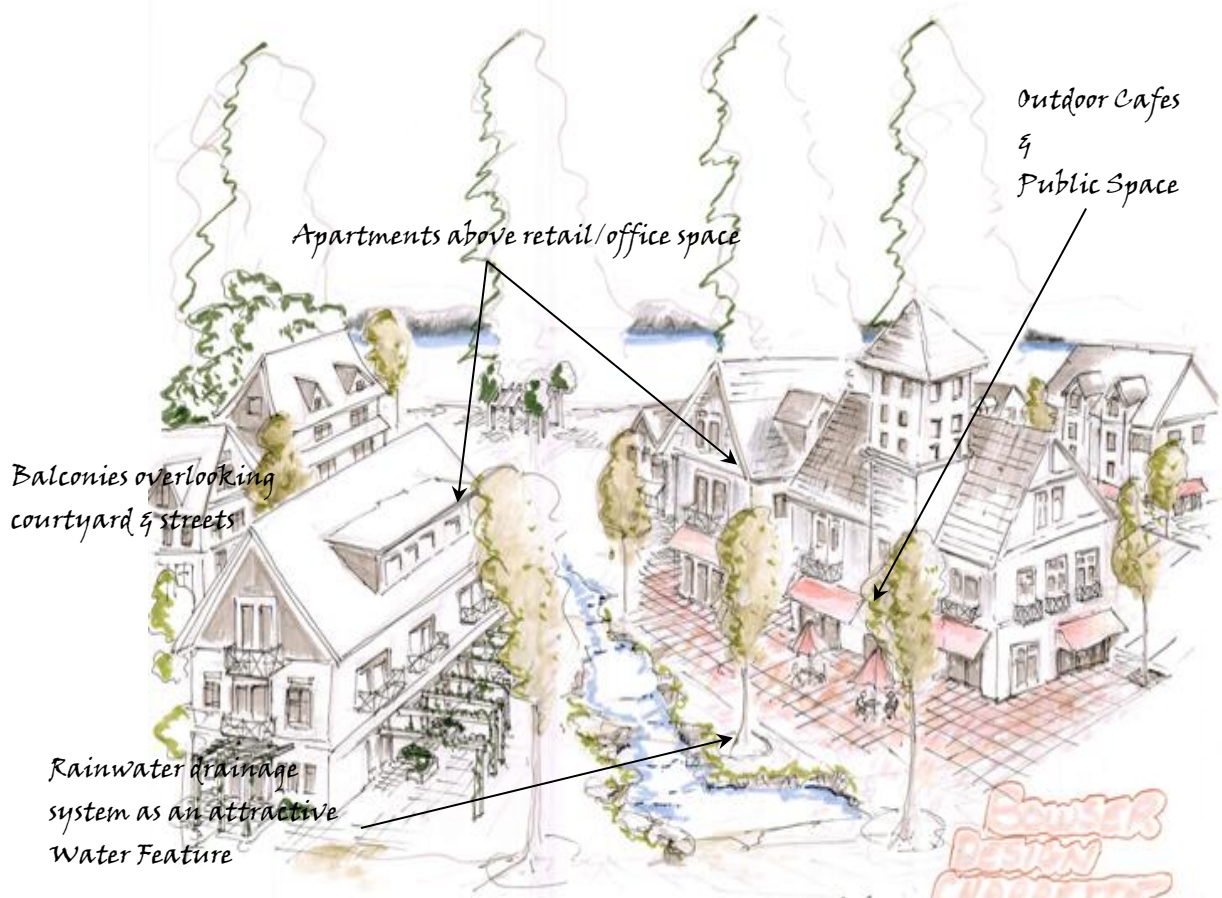

4 Land Use Concept & Designations

4.2.2 Commercial - Tourist

Intent

The Commercial Tourist designation is intended to accommodate a range of 'village scale' commercial uses which support tourism activities. The locations of these areas are intended to take advantage of waterfront views and access and complement the village scale retail uses allowed in the Commercial Mixed Use designation.

Land Uses

The types of village scale uses that are supported in the Commercial-Tourist designation include but are not limited to:

- Commercial uses that support tourism
- hotels, motels
- Rental cabins/ cottages
- Guest houses
- Tourist related retail (gift shops, art galleries)
- Information Centres
- Tour centres
- Recreational rentals (boat rentals)
- Cafes, restaurants
- Residential
- Open Space
- Home Based Business

Building Arrangement

- Retail uses at street level
- Residential uses at and above street level
- Tourist accommodation uses at and above street level

Building Height

See Map 4.1.4

Building Types

- Low rise apartments above retail shops
- Clustered multi-residential developments/tourist accommodation adjacent to retail
- Attached or stacked town houses

Target Residential Density

10 Units per hectare (4 units/acre) by 2040

Target Tourist Accommodation Density

The target Floor Area Ratio for tourist accommodation is 1

Orientation

Focus buildings to face the street
Focus patios, balconies, and porches to face street and/views

Parking

On street, behind buildings or underground

Access

Discourage direct vehicular access from Highway No. 19A. Use side streets, collector roads or shared driveways.

Pedestrian & Cycling Access

Promote pedestrian, scooter and cycling linkages. Provide cycling and scooter parking/racks.

Features

Public courtyards, green space, seating areas, outdoor cafes, restaurants. Green roofs, decks, balconies overlooking streets / views.

See DPA Guidelines for further direction

Residential – High Density 4.2.3

Intent

The Residential–High Density designation is intended to allow for higher concentrations of people living in Bowser Village Centre by providing opportunities for a range of housing types in close proximity to employment opportunities, shops and services, recreational amenities and transit options. Affordable housing options for seniors, single parent and low income families is an important component of this land use designation.

Land Uses

Uses appropriate to Residential-High Density include but are not limited to:

- Single, two, three and four family dwelling units
- Secondary suites
- Carriage homes
- Garden suites
- Home based business
- Multi–unit residential
- Seniors housing
- Affordable housing
- Apartments
- Town homes
- Parks and Open Space
- Tourist accommodation as a home based business use

Building Arrangement

- Residential use at and above street level
- Secondary suites within primary single family dwelling units or detached at rear or side

Building Height

See Map 4.1.4

Target Residential Density

45 Units per hectare (18 units/acre) by 2040

Building Types

- Single family
- Duplex
- Triplex

- Fourplex
- Clustered town homes
- Low rise apartment buildings

Orientation

Focus buildings to face the street

Parking

On street (parallel to the street), behind, to the side or underground of buildings

Access

Discourage direct vehicular access from Highway No. 19A. Use side streets, collector roads, laneways or shared driveways.

Pedestrian & Cycling Access

Promote pedestrian, scooter and cycling linkages. Provide cycling and scooter parking/racks in multi-residential developments.

Features

Green space, community gardens, parks, green roofs/decks/balconies. Balconies overlooking streets and/views.

RURAL DENSITY DEFINED

The meaning of High Density in the context of this plan relates directly to a rural rather than urban context.

Accordingly, building heights (maximum 2 storeys or 3 storeys—see Map 4.1.4), limit residential density to a scale that is appropriate for a rural village.

While this level of development might be considered low density in an urban context, in relationship to the desired retention of larger lots outside of the Bowser Village Centre it is considered higher.

See DPA Guidelines for further direction

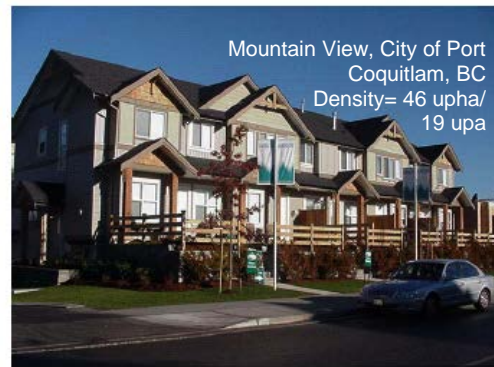

4 Land Use Concept & Designations

4.2.4 Residential – Medium Density

Intent

The Residential–Medium Density designation is intended to facilitate infill and densification of medium density residential areas in close proximity to commercial areas while providing a transition area or buffer between residential uses adjacent to the Bowser Village Centre. This designation also aims to provide a range of housing types to allow a greater range of choice and affordability.

Land Uses

Uses appropriate to Residential-Medium Density include but are not limited to:

- Single and two family dwelling units
- Secondary suites
- Carriage homes
- Garden suites
- Seniors housing
- Affordable housing
- Home based business
- Parks and Open Space
- Tourist accommodation as a home based business use

Building Arrangement

- Residential use at and above street level
- Secondary suites within primary single family dwelling units or detached at rear or side

Building Height

See Map 4.1.4

Target Residential Density

35 Units per hectare (14 units per acre) by 2040

Building Types

- One-two storey single/two family dwelling units

Character

Focus buildings to face the street

Parking

On street (parallel to the street), behind, to the side or underground of buildings

Access

Discourage direct vehicular access from Highway No. 19A. Use side streets, collector roads, laneways or shared driveways.

Pedestrian & Cycling Access

Promote pedestrian, scooter and cycling linkages.

Features

Green space, community gardens, parks, green roofs/decks/balconies. Balconies overlooking streets and/views.

See DPA Guidelines for further direction



Intent

The Civic and Cultural designation is intended to provide for a range of civic and cultural uses at a suitable village scale to meet the needs of Bowser Village Centre and surrounding rural / residential areas. This includes outdoor spaces for community use for informal gathering and temporary markets/ festival (arts and cultural events).

To encourage the development of multi-functional sites and buildings which maximize energy efficiency and conserve land use

Land Uses

Uses appropriate to the Civic and Cultural designation include but are not limited to:

- Parks, open space, playgrounds
- Educational uses
- Arts
- Transit (railway station/platform, railway, bus station)
- Temporary outdoor markets
- Schools
- Seniors housing
- Affordable housing
- Police, fire and ambulance stations
- Government offices
- Museums
- Clinics
- Recreational and cultural centres
- Libraries
- Post offices
- Churches

Building Arrangement

- 1-2 storey institutional buildings
- 1-2 storey ground oriented multi-residential units
- 1-3 storey multi-residential/mixed use buildings
- Clustered multi-residential units

Building Height

See Map 4.1.4

Target Residential Density

35 Units per hectare (14 units per acre) by 2040

Building Types

- One-two storey public buildings
- Clustered multi-residential units
- Attached or stacked town houses
- Low rise apartment buildings

Building Size

Maximum building size 1,000 sq m (10,764 sq ft) except for residential buildings.¹²

Character

Focus buildings to face the street/views

Parking

Behind, to the side or underground of buildings

Access

Discourage direct vehicular access from Highway No. 19A. Use side streets, collector roads, laneways or shared driveways.

Pedestrian & Cycling Access

Promote pedestrian, scooter and cycling linkages. Provide cycling and scooter parking/racks in multi residential developments.

Features

Porches, balconies, green space, green roofs/ decks.

See DPA Guidelines for further direction



¹³ Bylaw 1335.06, Adopted December 12, 2017

4 Land Use Concept & Designations

4.2.6 Parks & Open Space

Intent

The Parks and Open Space designation is intended to retain and create valued green space that:

1. enhances ecological functions through use of green space for riparian protection, habitat conservation, green infrastructure (catchment ponds, rain gardens, green streets);
2. improves community health and mobility by providing safe opportunities for walking and cycling and other recreational opportunities, and
3. provides a pleasing aesthetic environment for the enjoyment of residents and visitors alike.

Land Uses

Uses appropriate to the Parks and Open Space designation include but are not limited to:

- Parks
- Open space
- Playgrounds
- Community gardens
- Trails, greenways/green streets, green corridors, rainwater management facilities

Features

- Conservation and habitat enhancement areas, trails, green streets, porous surfaces.
- Rainwater management amenities for public benefit including swales, rain/storm water catchment ponds, and rain gardens.
- Edible landscaping.
- Streamside protection (riparian) areas.
- Maps and informational signage to highlight natural, environmental, archaeological and culturally significant features.

Map 4.2.6 Ideas for potential future greenways, parks and trails¹⁴

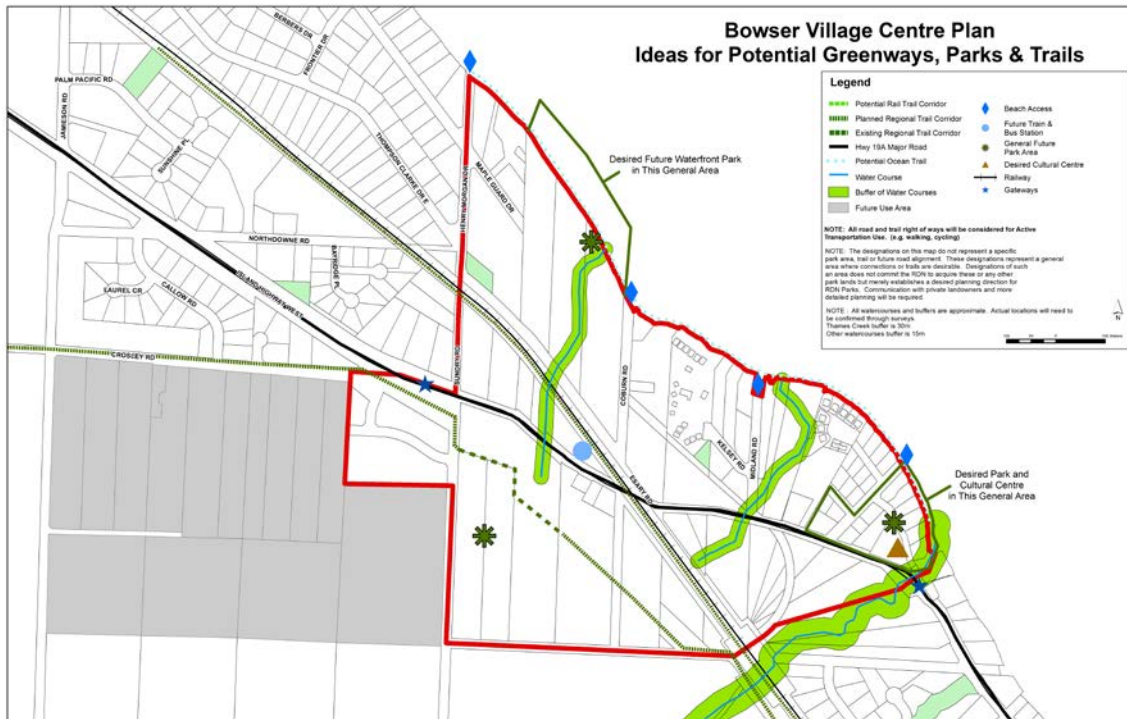

¹⁴ Bylaw 1335.06, Adopted December 12, 2017

Intent

The Future Use Area designation identifies lands to be reserved to accommodate future demand for commercial, commercial service/light industrial, residential, civic and cultural uses within Bowser Village Centre. Potential development of these lands should enhance the overall development of Bowser Village Centre as a 'compact, complete community'.

The conversion of lands to higher intensity uses within the 'Future Use Area' designation shall only be permitted when it can be clearly demonstrated that:

- land within the original Bowser Village Centre Boundary has been fully utilized for the designated land uses.
- the land is necessary to accommodate demand for the proposed land use.
- proposed land uses will complement and enhance existing land uses in Bowser Village Centre and that such conversion shall not contribute to 'leapfrog' or scattered development patterns.
- Prior to any conversion of these lands, a comprehensive land use plan will be developed showing how the 'Future Use Area' will connect to and complement the existing Bowser Village Centre.

See Map 4.2.7 as one example of potential land uses in the Future Use Area.

Map 4.2.7 Example of one concept for land uses for the Future Use Area¹⁵

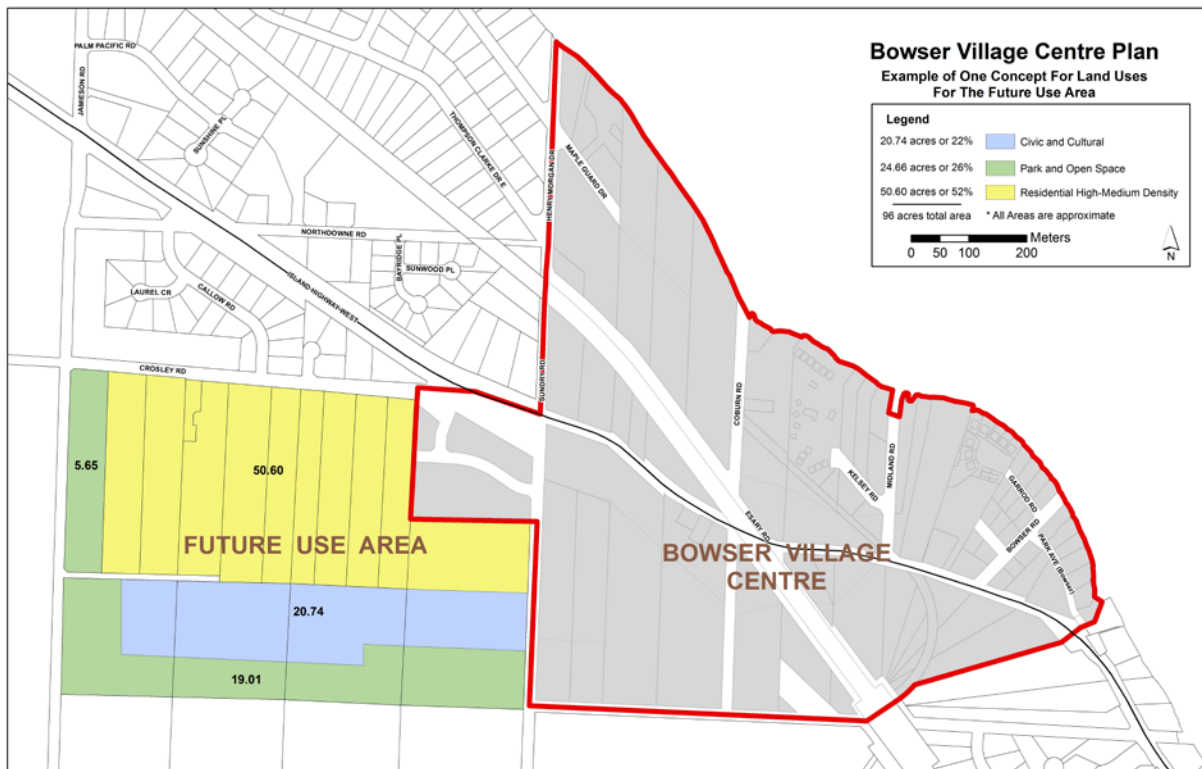

¹⁵ Bylaw 1335.06, Adopted December 12, 2017



BOWSER VILLAGE CENTER

DEVELOPMENT PERMIT AREA

Section 5

Table of Contents

1. Designation
2. Authority
3. Justification
4. Objectives
5. Design Concepts

Development Permit Area 5

1. DESIGNATION

The Bowser Village Center Development Permit Area is shown on Map No.6 and applies to the Bowser Village Centre.

2. AUTHORITY

The Bowser Village Center Development Permit Area is designated a development permit area for the following purposes, pursuant to Section 488(1)(a)(e)(f)(h)(i)(j) of the *Local Government Act*:

- (a) protection of the natural environment, its ecosystems and biological diversity;
- (e) establishment of objectives for the form and character of intensive residential development;
- (f) establishment of objectives for the form and character of commercial, industrial or multi-family residential development;
- (h) establishment of objectives to promote energy conservation;
- (i) establishment of objectives to promote water conservation; and
- (j) establishment of objectives to promote the reduction of greenhouse gas emissions.

3. JUSTIFICATION

The Bowser Village Centre Development Permit Area has been designated in recognition of the community's desire to see Bowser Village Centre evolve into a 'compact', 'mixed-use' village where people can live, work, play and learn in a safe, healthy and attractive environment.

Historically, for the past 90 - 100 years, the Bowser Village Center has been the location for businesses providing products and services to the wider community. The community has expressed its desire to see Bowser Village Centre maintain its role as focal point supporting a variety of commercial, recreational, community and professional services, and to gradually become a more vibrant mixed use core with residential uses close to shops, services and other amenities. Further to this, the community vision is to become a more sustainable community in terms of environmental and groundwater protection and to incorporate features and construction standards that promote more efficient use of energy and water resources. In addition, the Bowser Village Center is intended to reduce greenhouse gas emissions through the more efficient building design and active transportation uses.



The Bowser Hotel with Charlie "Cappy" and Florence Winfield, 1920 circa.
Photo by: Janice Young.

Development Permit Area 5

4. OBJECTIVES

1. Create a more compact village center that supports a diverse, healthy population by allowing a mix of land uses that encourages a range of housing affordability and types, services, employment and recreational arrangements.
2. Provide a safe and cohesive pedestrian-oriented environment with strong connections within Bowser Village Center and between adjacent neighbourhoods.
3. Enhance and integrate the relationship between the built and natural environment through building design and landscaping.
4. Ensure that ground and surface water resources are protected from potential negative impacts associated with development.
5. Promote energy efficiency, water conservation and the reduction of greenhouse gas emissions through innovative building design, site planning and management.
6. Create a 'sense of place' through effective design that reflects and enhances the valued rural character of the area.
7. Provide a clearly defined attractive entrances to the community.

5. DESIGN CONCEPTS

The following design concepts were identified by local residents at the Bowser Village Charette (Design Workshop) held June 8-9, 2009:

1. Increase visual appeal, starting from the points of entry into the Bowser Village; these points of entry are the intersection of Crosley Road and Highway 19A and the intersection of McColl Road and Highway 19A.
2. Create a pedestrian friendly environment through design, height and siting of buildings (3 storey heights, buildings close to street, accessible sidewalks, parking to the rear of buildings out of sight of roads and highway).
3. Use natural systems as 'green infrastructure' with a network of streets and parks performing natural drainage functions and providing a pedestrian friendly environment.
4. Increase greenways and separate pedestrians from vehicles by green borders, boulevards and swales; slow down traffic, and improve safety.
5. Group similar commercial activities together so that residents can park once and then walk to several destinations.
6. Encourage live-work buildings, where owners might live above their businesses
7. Increase density of residences and of commercial space in order to gain green-space around the buildings.

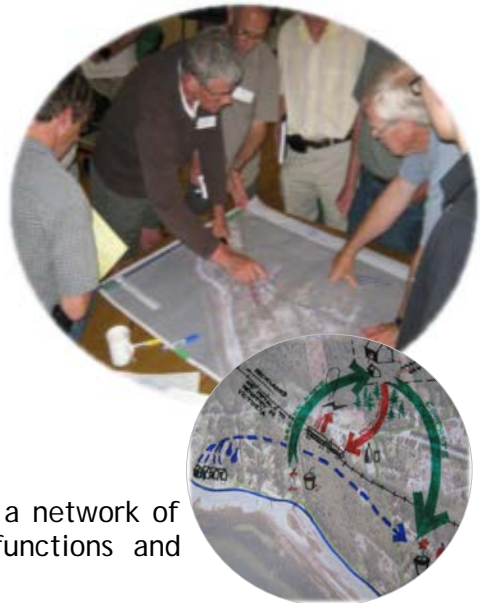

Appendix A Glossary

APPENDIX A
Glossary

THIS PAGE INTENTIONALLY BLANK

Glossary of Terms and Definitions

Affordable Housing: Housing for those who would find it challenging to pay full market price to either rent or own a home. The Canada Housing and Mortgage Corporation (CMHC) specifies that for housing to be considered affordable the cost of mortgage or rent should not exceed 30% of a householders gross income. Affordable housing may include; rental housing at or below market rents; market or non-profit housing targeted for seniors, low income singles/ families or those with disabilities; or housing for first time home owners.

Active Transportation: refers to all human-powered forms of travel - the most popular forms are walking and cycling, and is often combined with other modes, such as public transit. (Source: Physical Activity Strategy: BC on the Move <http://www.physicalactivitystrategy.ca/index.php/beat/active-transportation/>)

Ageing in Place: Term used to express the concept of designing buildings and communities to meet the different needs of residents as they get older so that they are not forced to leave their home or community as their housing and servicing needs change (See **Universal Design**). This may entail wheelchair accessible housing and interior layouts, hardware designed for use by those with limited physical ability (light switches, door handles, railings, plumbing fixtures, counters, cupboards and appliances in bathrooms and kitchens). A key aspect of a community that accommodates ageing in place is a diversity of housing options to meet different needs. This includes affordable housing in close proximity to public transportation and services.

Articulation: The use of building design elements (windows, balconies, entrances), materials, colours and textures to divide a large building façade into distinct sections. Articulation can be used to create a pattern and rhythm of design elements that make streetscapes attractive to pedestrians. (See Massing)

Attached Townhomes: Attached single-family houses on individual strata lots. Townhouses share a common wall with one or two adjacent units. (See Townhouse)

Built Environment: refers to all human-made surroundings -the spaces where we live, work and play. The built environment includes tangible structures, such as buildings, streets, parks, businesses, schools, road systems, transportation networks, and other infrastructure. (Source: Physical Activity Strategy: BC on the Move <http://www.physicalactivitystrategy.ca/index.php/beat/active-transportation/>)

Built Environment and Active Transportation (BEAT): is a joint initiative between the BC Recreation and Parks Association and the Union of BC Municipalities (funded through the BC Healthy Living Alliance), that promotes changes in the planning and design of the Built Environment to increase Active Transportation in communities throughout British Columbia. (Source: Physical Activity Strategy: BC on the Move <http://www.physicalactivitystrategy.ca/index.php/beat/active-transportation/>)

Bylaw: A law created by the RDN to meet the needs of residents and address issues relating to public safety, land use planning, business activities and services provided

Appendix A Glossary

by the RDN. The Provincial legislation gives the RDN the legal authority to create bylaws (see Local Government Act). Examples of bylaws include zoning and official community plans.

Carriage Home: Houses joined to garages or carports which are separate from the main residence.

Civic Use: Use of a building or site for local government activities. This may also include public education, cultural performance, gatherings and displays administered by non-profit cultural, educational, and religious organizations.

Cluster Housing: A planning/design technique to group residences together in order to allow for more open space than might otherwise be permitted. It is a variation on the planned unit development concept, and often it is particularly applicable to rural development or small towns.

Commercial Use: building space used for the conduct of retail, office, artisan, restaurant, lodging, professional business, entertainment, and recreational uses.

Community Amenities - means any number of amenities important to the community such as, but not limited to the following: open space -parking structures in commercial areas -public plaza -off street pedestrian / bicycle facilities -public pier -bike racks / bike storage lockers -waterfront / creek walkway -employee shower facilities - child care / adult care facilities -recreation facilities -youth centre / senior's centre -streetscape improvements -extra landscaping -playground equipment - tree preservation -observation areas / decks -stream enhancement -multi-purpose community space -preservation of unique environments -cultural / entertainment facilities -preservation of heritage structures -rooftop landscaped public space - accessibility features -public art -underground parking

CPTED (Crime Prevention through Environmental Design): Refers to a group of strategies and concepts (including the design of buildings and landscaping) intended to reduce the fear of crime and opportunities to commit crimes.

Density: the number of dwelling units or buildings in an area usually expressed as units per hectare/acre or population per hectare.

Density Bonus: Refers to instances where a developer is allowed additional density (more than allowed under existing zoning) in exchange for providing a **Community Amenity**. This can take the form of financial contributions or the actual development of amenities including parks, cultural or recreational buildings and affordable housing units.

Density Transfer: Refers to moving/transferring the ability to develop a certain number of dwelling units (as allowed under existing zoning) from one lot to another. Can be used to help preserve environmental, heritage values on a donor site (site giving density) and to increase density to help build more compact development on a receiving site.

Development Permit Area: A Development Permit Area (DPA) is established to

address a concern or issue that cannot be addressed through zoning regulations relating to an area specified by an Official Community Plan or Village Plan. The authority for the RDN to establish DPAs is set out in the Local Government Act, Sections 919.1 and 920.

A development permit is generally required prior to building and subdivision or alteration of land within a DPA. Issue such as protecting the natural environment and protecting development from a natural hazard can be addressed through a development permit.

Duplex: A building with two self-contained dwelling units with separate outside entrances sharing a common roof. The units may be stacked, side by side or front and back.

Façade: Refers to the exterior 'face' of a building, from ground level to the roof and from side to side. May refer to front, side or rear facade.

Fast Tracking: Term used to refer to a method/s of expediting the application process for a development. These methods are used by other local governments as incentives to encourage certain types of development. For example, development that meets environmental and social objectives such as green buildings or affordable housing projects.

Note - the RDN does not currently have such a system in place.

FAR (Floor Area Ratio) also known as FSR (Floor Space Ratio):

FAR-Relationship or ratio of total horizontal building floor area to lot area (also known as floor space ratio, floor area ratio or floor space index). For example a building of 5,000 m² on a 10,000 m² lot has a FAR of 0.5 or a 20,000m² building on a 10,000m² lot has a FAR of 2:1. Also see **Density**.

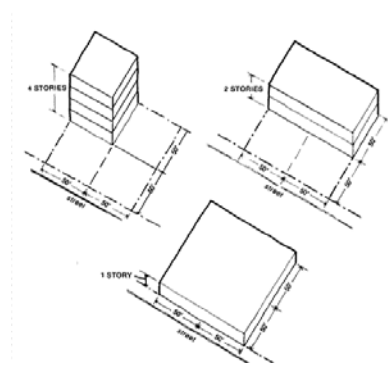

Three examples of buildings with an FAR of 1:0

Full Cut Off (FCO) Light:

A light fixture with a flat glass panel beneath which, when mounted horizontally, emits no light above the horizontal.

<http://www.britastro.org/dark-skies/glossary.html>

Garden suites or Granny Flats: Detached suites on single family lots above garages or

Appendix A Glossary

in accessory buildings. Garden suites can also be ground level suites within a main residence. Source West Coast Environmental Law website <http://www.wcel.org/issues/urban/sbg/glossary/>

Green Infrastructure: means use of processes and systems that are natural or mimic nature to provide community services (i.e. design with nature). It means using natural systems for community services like rainwater management, water treatment and public space.

<http://www.waterbucket.ca/gi/index.asp?sid=5&id=15&type=single>

Green Space: Public or private land that is in a vegetated state. It can be landscaped with lawns and shrubs or it may consist of natural vegetation.

Green Streets: aim to manage storm water runoff as a resource rather than a waste. A Green Street can be defined as a street designed to:

- Integrate a system of rainwater management within its right of way.
- Capture rainwater runoff and allow it to soak into the ground as soil and vegetation filter pollutants.
- Reduce the amount of water that is piped directly to streams and rivers.
- Be a visible component of a system of “green infrastructure” that is incorporated into the aesthetics of the community by creating attractive streetscapes that connect business areas, neighbourhoods, parks and schools.
- Make the best use of the street tree canopy for rainwater interception as well as temperature mitigation and air quality improvement.
- Ensure the street has the least impact on its surroundings, particularly at locations where it crosses a stream or other sensitive area.



Green streets can be designed to accommodate the needs of pedestrians, bicyclists and vehicles.

Definition from combined directly from the following two sources:

Charles River Watershed Association Weston Massachusetts, USA

<http://www.crwa.org/projects/ESUD/GreenStreet.pdf> and City of Portland, Oregon, USA <http://www.portlandonline.com/bes/index.cfm?a=196299&c=47012>

Greenways/ Green Corridors:

A network of pathways, bikeways, waterways or undeveloped networks of green space, featuring view points, heritage resources and natural wildlife habitat and vegetation.

Height: The distance measured vertically between the natural grade and the highest

point of the roof of a building. Height can also mean the number of floors or storeys.

Human Scale: refers to the design of buildings or sites to relate well to average human proportions and preferences. Human scaled buildings and environments are physically comfortable and psychologically attractive for people who use them. Human scaled environments are focused towards pedestrians rather than vehicles.

Industrial Use: For the purposes of this plan industrial use means the wholesale, warehousing, testing, service, repair or maintenance of an article, substance, material, fabric or compound, and includes artisan and manufacturing shop, having a gross floor area not exceeding 200 sq. meters, and retail sales accessory to the principal use. Where business operations can be carried out without disrupting adjacent uses through noise, odour, vibration, heat, high illumination levels, and waste generation; and where operations do not compromise the quality and quantity of surface and groundwater and air quality.

Institutional Development:

Means land used for any public or private entity or agency that operates to provide a community service (including regional provincial, federal, school districts, improvement districts and other agencies). Institutional uses may include schools or other educational facilities, libraries, seniors care facilities, cultural centres, and medical facilities.

Infill Development:

The new buildings on vacant or underused sites within a built-up area. This may be via subdivision of large lots to smaller ones, additions to existing buildings, e.g., by building on an existing sideyard, or redevelopment of an underutilized site.

Interface Fire: term used for fires that have the potential to simultaneously involve both structures (and other man-made developments) and wildland fuels.

Source: Bowhorn Bay Community Wildfire Protection Plan. Strathcona Forestry Consulting, July 2007

Land Use: type of activity present on a property. Typical examples may include: retail, office, light industrial, residential, institutional and park.

LEED™: The Leadership in Energy and Environmental Design (LEED) Green Building Rating System™ is a third-party certification program and an internationally accepted benchmark for the design, construction and operation of high performance green buildings. It provides building owners and operators the tools they need to have an immediate and measurable impact on their buildings' performance.

LEED promotes a whole-building approach to sustainability by recognizing performance in five key areas of human and environmental health:

- sustainable site development
- water efficiency
- energy efficiency
- materials selection
- indoor environmental quality

Appendix A Glossary

Source: <http://www.cagbc.org/leed/what/index.php>

Live/Work Unit: means a building that includes space for a commercial use, generally on the ground floor, and a residential unit as the principal residence for the business operator or an employee.

Local Government Act (B.C.): A Provincial law that sets out the legal framework for municipalities and regional districts to create bylaws, budgets, undertake local services, regulate land use, and development of plans.

See: <http://www.bclaws.ca/>

Lot Coverage: The maximum area of a lot that may be occupied by a building/structure or other impervious surfaces such as paving. Lot coverage may be expressed as a percentage or total area.

Mass: Refers to the overall three-dimensional shape of a building and its scale in relation to its surroundings. Massing includes a combination of size, form, footprint, and height. The mass of a three storey building can be 'reduced' by varying architectural treatments including 'stepping' back upper floors, incorporating third floors into rooflines, using building articulation (use of different materials, colours and location of windows, doors and balconies) to give the appearance of a series of smaller buildings as opposed to one 'massive' structure. (See Articulation and Modulation)

Mixed-Use: Different uses in relatively close proximity to each other either within the same building, site or neighbourhood. A mixed use building might contain retail shops at street level with apartments or offices above. A mixed use site might contain a combination of residential, commercial and institutional uses. A mixed use neighbourhood might contain a wide range of housing types from apartment buildings, single family dwellings, townhouses, retail shops, offices, institutional uses (such as schools, hospitals, daycares, government buildings, recreational or cultural).

Modulation: Refers to 'stepping back' or 'projecting forward' of portions of a building face, within specified intervals of building width and depth. This can be used to achieve building articulation and reducing the apparent bulk/mass of a structure's continuous exterior walls. (See Stepping Back, Massing and Articulation)

Multi-family/ Multi-residential: Refers to a building or lot containing more than one dwelling unit. This includes apartments, townhouses, fourplexes, triplexes, and duplexes.

OCP/Official Community Plan: A general statement, in the form of a bylaw, of the broad objectives and policies of the local government respecting the form and character of existing and proposed land use and servicing requirements in the area covered by the plan. It provides the policy framework for developing the detailed policies in the village centre plans.

Office Use: Premises used for services, including professional, financial, clerical, administrative and medical.

Orientation: Direction that a building (including windows, balconies, patios and entrances) or site is facing. This may be in relation to the street, pedestrian paths, open space, views or climate and energy considerations (solar gain, wind protection).

Public Realm: Refers to all areas where the public has open access including streets/road right of ways, parks, open courtyards, and public amenities such as cultural, civic or recreational buildings.

Rain Gardens: Landscaped collection basins designed to infiltrate water into soils. Rain gardens can assist with improving groundwater recharge and reducing surface run-off while being aesthetically pleasing.

Reception Centre: A term used to describe a site where evacuees may be received during a disaster. This may be a facility such as a recreation centre, church hall, school, hotel lobby, or even a tent -it depends on what is available in the community or what is needed. Source: BC Ministry of Public Safety and Solicitor General Website <http://www.ess.bc.ca/reception.htm>

Regional District: A provincially established group of local governments and administrative districts providing coordinated services to both urban and rural parts of a region. It is managed by a board of directors appointed from the member municipalities and electoral areas.

Regional districts were formed in the mid-1960s to perform two functions: to deliver local services to areas outside of municipalities and to provide a way for municipalities and rural areas to jointly fund services which benefit the entire region. Provincial laws provide regional districts with their mandate and authority to carry out services (see *Local Government Act*).

Regional District of Nanaimo: The Regional District of Nanaimo (RDN) covers over 2000 km² of land extending along the coast of Vancouver Island from the rural communities of Deep Bay to Cedar in the South. The RDN includes unincorporated rural communities like Deep Bay, Bowser, Qualicum Bay, Dashwood, Coombs, Errington, Nanoose Bay, Mudge Island, Gabriola, East Wellington, South Wellington, Extension and Cedar. The RDN also includes the Town of Qualicum Beach, City of Parksville, District of Lantzville and City of Nanaimo.

Regional Growth Strategy: The RDN Regional Growth Strategy (RGS) developed and approved by the member municipalities and the regional district in partnership, on social, economic and environmental goals and priority actions.

A regional growth strategy (RGS) is a local government strategic plan to promote human settlement that is socially, economically and environmentally healthy and that makes efficient use of public facilities, land and other resources. An RGS gives long range planning direction for regional district and municipal official community plans (OCPs) and provides a basis for decisions regarding implementation of provincial programs in the area. (Source Ministry of Community and Rural Development website: http://www.cd.gov.bc.ca/LGD/planning/growth_strategies.htm)

Appendix A Glossary

Residential Use: Premises used primarily for human habitation.

Retail Use: Premises used for the sale of services or goods.

Row house: Attached single-family dwellings on individual strata lots. Row houses share common walls with one or two adjacent units.

Seniors Housing: Housing for those aged 55 years and up.

Setbacks: The distance between a lot line or natural boundary and the edge of a building or structure.

Shared Parking: Parking spaces assigned to more than one use where persons utilizing the spaces are unlikely to need the spaces at the same time of day.

Stacked Townhouse: Usually consists of two-storey homes stacked one on top of the other in a row of four or more homes. The units may have more than one level. All units have direct access from the outside. (Source -Canada Housing and Mortgage Corporation website: <http://www.cmhc-schl.gc.ca>)

Stepping Back: Use of building modulation to set back upper floors of a building from the ground floor front façade. Useful technique for creating a more pedestrian friendly and human scale streetscape. For example, the third floor of a three storey building can be set back from the first two floors to give the impression of a two storey building façade. Can also be used to reduce the mass of a building on a sloped site and protect view corridors. (See Modulation and Massing)

Storey: A habitable floor level within a building.

Street Furniture: includes a wide variety of elements designed for public convenience along streets or sidewalks such as lighting, fire hydrants, signs, benches, transit shelters, bicycle racks, waste/recycling containers, bollards and planters.

Swale: a vegetated strip of land designed to collect and hold rainwater runoff, clean it with natural soil and vegetation filters, and then infiltrate it into the ground.

Traffic Calming: Measures taken to slow traffic and improve safety conditions for pedestrians along roads in local communities. These may include the use of signage, different paving surfaces, roundabouts, speed bumps, perceived and actual narrowing of streets/roads. Visual cues include bringing buildings closer to streets, uses of landscaping and street furniture.

Tourist Accommodation: Accommodations for people who normally reside elsewhere, e.g., hotel, motel, resort cottages, and bed and breakfast.

Townhouse: Attached single-family dwellings on individual strata lots. Townhouses share a common wall with one or more adjacent units.

Universal Design: This means the design of products and environments to be useable by all people, to the greatest extent possible without the need for adaptation or

specialized design. In the context of housing design, universal design means designs that minimize or eliminate restrictions to occupant movement, usually included in homes for seniors or people with disabilities. Examples include wider hallways, wider doorways, ramps, etc.

Village Centre: The historic and traditional centres in unincorporated areas. These centres are intended to be developed to include a mix of higher density residential, commercial, institutional and recreational uses that support the areas rural character and quality of life. They include places to live, work, learn and play and access services and are supported by appropriately scaled public works infrastructure. They should be linked to surrounding neighbourhoods through green space, parks, roads, walking trails, and bicycle paths.

Village Centre Plan: A plan that outlines a community's vision, principles, policies and guidelines for managing change in a designated village centre. It generally provides detailed information about future land use change.

Wildland Urban Interface (WUI): the area where structures, businesses, and other human activities and pursuits are situated among trees and other combustible vegetation.

Source: Bowhorn Bay Community Wildfire Protection Plan. Strathcona Forestry Consulting, July 2007

Woonerf: A Dutch term for a traffic calmed street where pedestrians and cyclists have priority over motorists. Street design and low vehicle speeds allow streets to be used as a public living room for children and adults to gather and play.



Mole Lane, City of Vancouver. Source www.cityfarmer.org/mole.html

Key woonerf design features include:

- gateways marking the entrance to a woonerf area;
- curves to slow vehicle traffic;
- street trees, landscaping, play equipment and street furniture that provide environmental and recreational amenities as well as forcing vehicles to slow down;
- no curbs; and
- intermittent parking so that cars do not form a wall of steel between the roadway and houses

Appendix A Glossary

Source: Donald Appleyard *Livable Streets*, Berkeley, CA: University of California Press, 1981.

Zero Waste: A goal and a process that involves individuals, communities and local, provincial and federal governments sharing a vision of a future where garbage is a thing of the past.

Zero Waste focuses on reducing the RDN's environmental footprint by minimizing the amount of waste that enters landfills through reduction, reuse, recycling, redesign, composting, and other actions.

Source: <http://www.rdn.bc.ca/cms.asp?wpID=1063>

Zoning: The division of a municipality or regional district by bylaw, into different zones in which different aspects of land use is regulated including: lot size; density/intensity of use; land use; and, the siting, size, shape and height of buildings (e.g. RDN Bylaw No. 500).

Appendix B Public Process

THIS PAGE INTENTIONALLY BLANK

Public Participation Process

The development of the Bowser Village Plan involved an extensive public consultation process involving residents, landowners and business owners. The public consultation process was initiated by an Open House on June 9th 2008 followed by 23 further public events / community Advisory Group meetings. This public consultation reflects the direction of the RDN Board and Area 'H' OCP and greatly augments the level of public consultation required by the *Local Government Act*.

The creation of a Village Planning Advisory Group was instrumental to community participation in the planning process. The Advisory Group provided guidance and feedback through a series of 15 meetings with meeting attendance ranging from approximately 30-80 people depending upon the meeting. Members of the Advisory Group were also actively involved in a range of events, giving presentations and collecting feedback from other community members. The Advisory Group also provided feedback in between meetings (via e-mail or in person) with approximately 100 people reviewing information and sharing their thoughts.

During the course of the project, the RDN provided a project office in Bowser with a staff member typically available on Fridays for discussion with community members. During some of these Fridays RDN staff took tours of the Village Centres and facilitated small group discussions on topics of interest to Advisory Group Members. Throughout the process, meeting agendas, notes and other documents were made available online, via-e-mail and through hard copies.

The table and project timeline chart below provides a summary of Advisory Group meetings and events associated with the project. It should be noted that all events and meetings were open to anyone to attend throughout the process.

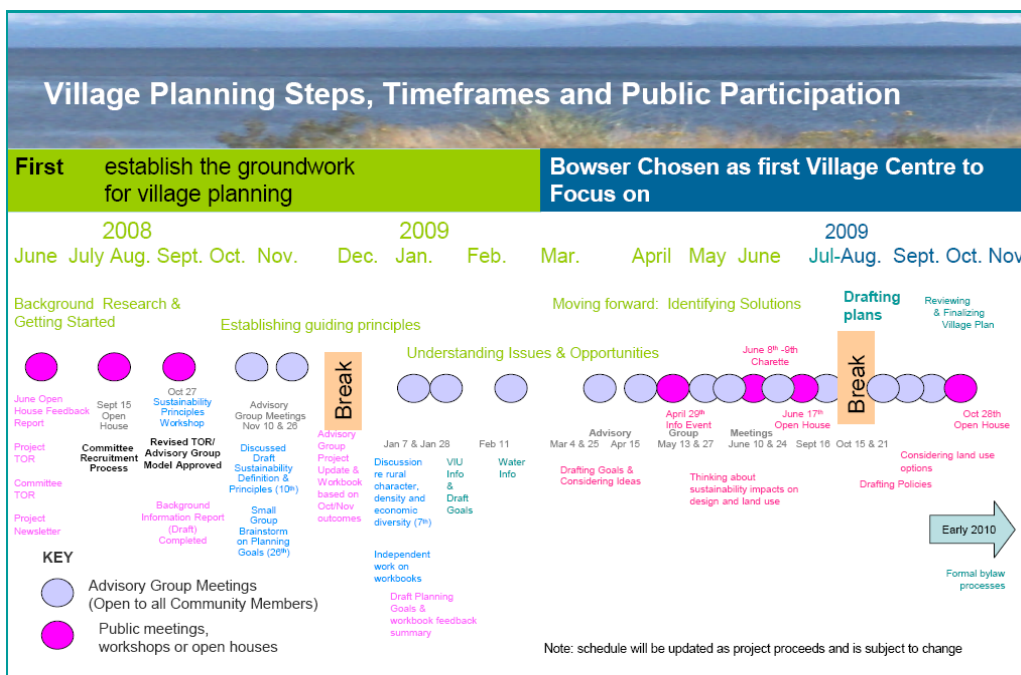

Appendix B Public Process

List of Meetings and Events

	Date	Event
1	June 9th 2008	OPEN HOUSE
2	Sept. 15th 2008	OPEN HOUSE
3	Oct. 27th 2008	SUSTAINABILITY PRINCIPLES WORKSHOP
4	Nov. 10th 2008	Advisory Group Mtg. #1
5	Nov. 26th 2008	Advisory Group Mtg. #2
6	Jan. 7th 2009	Advisory Group Mtg. #3
7	Jan. 28th 2009	Advisory Group Mtg. #4
8	Feb.11th 2009	Advisory Group Mtg. #5
9	March 4th 2009	Advisory Group Mtg. #6
10	March 25th 2009	Advisory Group Mtg. #7
11	April 15th 2009	Advisory Group Mtg. #8
12	April 25th 2009	HARBOUR FESTIVAL INFORMATION BOOTH
13	April 29th 2009	INFORMATION EVENT
14	May 13th 2009	Advisory Group Mtg. #9
15	May 27th 2009	Advisory Group Mtg. #10
16	June 8-9th 2009	BOWSER VILLAGE CHARETTE
17	June 10th 2009	Advisory Group Mtg. #11
18	June 17th 2009	OPEN HOUSE
19	June 24th 2009	Advisory Group Mtg. #12
20	Sept. 5th 2009	FALL FAIR INFORMATION BOOTH
21	Sept. 16th 2009	Advisory Group Mtg. #13
22	Oct. 15th 2009	Advisory Group Mtg. #14
23	Oct. 21st 2009	Advisory Group Mtg. #15
24	Oct. 28th 2009	OPEN HOUSE

June 9th 2008 Open House

Prior to developing a Terms of Reference for the Area 'H' Village Planning project, the RDN invited input from the community regarding village centres and village planning in Area 'H'. A key purpose of the June 9th Open House was to provide community members with the opportunity to comment on village centres, village planning opportunities and issues, and community priorities.

The results from this Open House and the survey were used to help staff prepare a Terms of Reference for the project.



September 15th 2008 Open House

An Open House was hosted by the RDN on September 15th to provide an overview of the project (including a draft terms of reference) and to encourage the community to participate in the process. During this Open House many community members conveyed a strong desire to be involved in the process.



October 27th 2008 Sustainability Principles Workshop

The purpose of this workshop was to establish a set of sustainability principles to guide the project. It was the first opportunity in the project for residents to share ideas and perspectives on what a more sustainable community might involve in the future. The event was led by two special guest facilitators, Ms. Angela Evans from the Fraser Basin Council (Smart Planning for Communities) and Ms Su Hallatt, CitizenPlan (planning consultancy).

The results of the workshop were used as a foundation to create a set of sustainability principles to guide the project.



Appendix B Public Process

November 2008 – Community Advisory Group Established

Following the September 15th Open House and October 27th 2008 Sustainability Principles Workshop, a community Advisory Group was established. Fifteen Advisory Group meetings were held between November 2008 and October 2009. Advisory Group meetings were open to anyone to attend with new members joining throughout the process.



November 2008 - February 2009

Between November 2008 and February 2009, the focus of Advisory Group meetings involved developing and refining a set of Sustainability Principles & Goals for the project. Several meetings included hearing presentations from different agencies involved in key issues affecting planning for Village Centres in Area 'H' including the availability of drinking water and discussions on groundwater quality.

March 2009 - Focus on Bowser

In early March 2009, the Village Planning Advisory Group decided to focus planning efforts on Bowser Village Centre. Choosing Bowser as the first village area to be addressed was regarded as an effective way of making use of remaining time and resources between March and October 2009. It was anticipated that the lessons learned from planning for Bowser Village Centre could then be applied when planning for other village areas within Electoral Area 'H' and the RDN as a whole.



March - May 2009 - Bowser Village Boundary Review

Following the decision to focus on Bowser Village Centre, the Advisory Group reviewed the existing Bowser Village Centre Boundary and developed a variety of alternatives to be considered. These alternatives were displayed at an Information Event on April 29th 2009.

During meetings on May 13th and 27th the Advisory Group debated the pros and cons of expanding Bowser Village Centre in a variety of directions based on concerns about having sufficient land allocated for future commercial, public and residential uses. This resulted in a decision to put forward a revised boundary for consideration for Bowser Village Centre showing an area for future extension to the West along Crosley Road.



April 5th 2009 - Deep Bay Harbour Festival Information Booth

RDN staff and members of the Advisory Group ran an information booth at the Deep Bay Harbour Festival on April 5th 2009. The purpose of the booth was to provide information on the Bowser Village Planning process, encourage participation in upcoming events, collect feedback and answer questions.



Appendix B Public Process

April 29th 2009 - Information Event

From January 2009 onwards, the Advisory Group started to gather information from presentations during meetings on a variety of issues and opportunities impacting Bowser. The need to quickly find out more about a range of issues and opportunities that affect planning for a sustainable Bowser Village Centre resulted in planning the April 29th Information Event.



The Information Event was also an opportunity for the Advisory Group to receive feedback on their different concepts for a boundary for Bowser Village Centre. Eleven different options for Bowser Village Centre were displayed including an option for keeping the existing Village Centre Boundary.

Approximately 67 community members attended the event (including Advisory Group Members). Information booths staffed by 26 staff from the RDN and other agencies

provided members of the Advisory Group and the wider community with an opportunity to have in depth, individual discussions about a range of topics including:

- Village Planning Project - Process, Sustainability Principles and Goals
- Potential Bowser Village Boundary Scenarios
- Land Use patterns under existing Zoning
- Regional Growth Strategy Review
- Children's Ideas for Bowser Village
- Sensitive Ecosystems
- Green House Gas Reduction Strategies (Presentation at 4:00 pm)
- Recreation, Parks & Trails (Presentation at 5:00 pm)
- Transportation Networks & Mobility
- Crime and Safety Strategies for Rural Villages (Presentation at 5:30 pm)
- Meeting Housing Needs - Affordable & Adaptive (Presentation at 6:00 pm)
- Wastewater options for Rural Villages (Presentation at 7:00 pm)
- Solid Waste options for Rural Villages
- Water - Quality, Quantity & Aquifer protection
- Rain & Storm Water Management
- Planning Strategies for Disaster Resilience
- Sustainable Rural Economic Development

Bowser Village Charette - June 8-9th 2009

During the course of two days on the 8th and 9th of June 2009, members of the Advisory Group and other Bowser residents worked alongside designers /landscape architects and planners who volunteered their time to help capture the community's vision of a sustainable Bowser Village Centre. Using the project's Sustainability Principles and Goals, the Charette participants produced a range of ideas of their vision for Bowser that was captured visually on maps and sketches. Amongst the many special guests invited to participate were Sebastian Moffatt, founder of the Sheltair Group and president of the CONSENSUS Institute (CONSTRUCTED ENVIRONMENTS and Sustainable Urban Systems), Randall Arendt, a conservation planner and site designer, and Peter Levar, Head of the Architectural Science program at the British Columbia Institute of Technology (BCIT) and three students from this program.

Ideas from the Charette included:

- Options for traffic calming together with improved pedestrian safety and access.
- Creating attractive 'gateways' or entrances to Bowser.
- Arranging land uses for housing, recreation/public space, transportation, retail and service land uses to create a more 'complete community'.
- Working with natural systems to develop eco-friendly infrastructure with ideas for 'green streets', rain gardens/catchment areas for enhanced rainwater management and pollution control.
- Ideas for alternative waste treatment, water conservation, recycling and energy generation and conservation. This included exploring septic treatment options for multiple dwellings that produce water for irrigation, use of wood waste to generate energy, and positioning buildings and streets for solar gain.



Appendix B Public Process

Open House - June 17th 2009

Several members of the Advisory Group and RDN staff presented the outcome of the June 8-9th Charette at an Open House on June 17th 2009. Also presented were three land use options 'bubble diagrams' that RDN staff put together based on the work done during the Charette.



Fall Fair Information Booth - September 5th 2009

RDN staff and members of the Advisory Group ran a Booth at the annual Fall Fair in Qualicum Bay. The purpose of the booth was to provide information on the Bowser Village Planning process, encourage participation in the process, collect feedback and answer questions.

September-October 2009

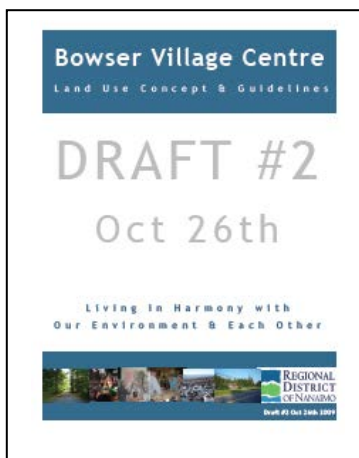

During September and October 2009 the Advisory Group provided feedback and guidance on the first draft of the Bowser Village Plan. This included reviewing and refining draft policies, agreeing upon the proposed land uses and recommending a land use map to be put forward in a second draft of the plan for the wider community to review.

Open House - October 28th 2009



On October 28th 2009, RDN staff and members of the Advisory Group presented the second draft of the Bowser Village Plan at an Open House. Members of the Advisory Group answered individual questions and collected feedback from the wider community.

The feedback from this meeting was used to make revisions resulting in the 'final draft' of the Bowser Village Plan to be carried forward to a 'formal' public process to include the Bowser Village Centre Plan as an amendment to the Area 'H' OCP.

